

**THEME: Environment (including climate change)**

**TOPIC: ENV.2011.2.1.2-1 Hydromorphology and ecological objectives of WFD**

**Collaborative project (large-scale integrating project)**

**Grant Agreement 282656**

**Duration: November 1, 2011 – October 31, 2015**



# REFORM

## REstoring rivers FOR effective catchment Management



Deliverable D6.2 Part 5

Title Final report on methods, models, tools to assess the hydromorphology of rivers - Part 5 Applications

Authors M. Rinaldi<sup>1</sup>, L. Nardi<sup>1</sup>, B. Belletti<sup>1</sup>, S. Bizzi<sup>2</sup>, K. Brabec<sup>3</sup>, F. Comiti<sup>4</sup>, L. Demarchi<sup>2</sup>, M. Giełczewski<sup>5</sup>, B. Golfieri<sup>6</sup>, H. Habersack<sup>7</sup>, S. Hellsten<sup>8</sup>, S. Kaufman<sup>7</sup>, M. Klösch<sup>7</sup>, E. Marchese<sup>4</sup>, P. Marcinkowski<sup>5</sup>, S. Muhar<sup>7</sup>, T. Okruszko<sup>5</sup>, A. Paillex<sup>9</sup>, M. Poppe<sup>7</sup>, J. Rääpysjärvi<sup>8</sup>, H. Seppo<sup>8</sup>, M. Schirmer<sup>9</sup>, M. Stelmaszyk<sup>5</sup>, N. Surian<sup>6</sup>, W. Van de Bund<sup>2</sup>

<sup>1</sup>UNIFI, <sup>2</sup>JRC, <sup>3</sup>MU, <sup>4</sup>Free University of Bozen-Bolzano, <sup>5</sup>WULS, <sup>6</sup>University of Padova, <sup>7</sup>BOKU, <sup>8</sup>SYKE, <sup>9</sup>EAWAG

Due date to deliverable: 31 July 2015

Actual submission date: 30 October 2015

Project funded by the European Commission within the 7<sup>th</sup> Framework Programme (2007 – 2013)

Dissemination Level

PU Public X

PP Restricted to other programme participants (including the Commission Services)

RE Restricted to a group specified by the consortium (including the Commission Services)

CO Confidential, only for members of the consortium (including the Commission Services)

\* Please cite the whole of Deliverable 6.2 as follows:

M. Rinaldi, B. Belletti, S. Bizzi, B. Blamauer, K. Brabec, G. Braca, M. Bussettini, F. Comiti, L. Demarchi, D. García de Jalón, M. Giełczewski, B. Golfieri, M. González del Tánago, R. Grabowski, A.M. Gurnell, H. Habersack, S. Hellsten, S. Kaufman, M. Klösch, B. Lastoria, L. Mao, E. Marchese, P. Marcinkowski, V. Martínez-Fernández, E. Mosselman, S. Muhar, L. Nardi, T. Okruszko, A. Paillex, C. Percopo, M. Poppe, J. Rääpysjärvi, M. Schirmer, M. Stelmaszczyk, N. Surian, W. Van de Bund, P. Vezza, C. Weissteiner (2015) Final report on methods, models, tools to assess the hydromorphology of rivers. Deliverable 6.2, a report in five parts of REFORM (REstoring rivers FOR effective catchment Management), a Collaborative project (large-scale integrating project) funded by the European Commission within the 7<sup>th</sup> Framework Programme under Grant Agreement 282656.

Please cite Part 5 of Deliverable 6.2 as follows:

M. Rinaldi, L. Nardi, B. Belletti, S. Bizzi, K. Brabec, F. Comiti, L. Demarchi, M. Giełczewski, B. Golfieri, H. Habersack, S. Hellsten, S. Kaufman, M. Klösch, E. Marchese, P. Marcinkowski, S. Muhar, T. Okruszko, A. Paillex, M. Poppe, J. Rääpysjärvi, H. Seppo, M. Schirmer, M. Stelmaszczyk, N. Surian, W. Van de Bund (2015) Final report on methods, models, tools to assess the hydromorphology of rivers, Deliverable 6.2, Part 5, of REFORM (REstoring rivers FOR effective catchment Management), a Collaborative project (large-scale integrating project) funded by the European Commission within the 7<sup>th</sup> Framework Programme under Grant Agreement 282656.

## Summary

### Background and Introduction to Deliverable 6.2

Work Package 6 of REFORM focuses on monitoring protocols, survey methods, assessment procedures, guidelines and other tools for characterising the consequences of physical degradation and restoration, and for planning and designing successful river restoration and mitigation measures and programmes.

Deliverable 6.2 of Work Package 6 is the final report on methods, models and tools to assess the hydromorphology of rivers. This report summarises the outputs of Tasks 6.1 (Selection of indicators for cost-effective monitoring and development of monitoring protocols to assess river degradation and restoration), 6.2 (Improve existing methods to survey and assess the hydromorphology of river ecosystems), and 6.3 (Identification and selection of existing hydromorphological and ecological models and tools suitable to plan and evaluate river restoration).

The deliverable is structured in five parts. Part 1 provides an overall framework for hydromorphological assessment. Part 2 includes thematic annexes on protocols for monitoring indicators and models. Part 3 is a detailed guidebook for the application of the Morphological Quality Index (MQI). Part 4 describes the Geomorphic Units survey and classification System. Part 5 (this volume) includes a series of applications to some case studies of some of the tools and methods reported in the previous parts.

### Summary of Deliverable 6.2 Part 5

This part provides a series of applications of some of the methods reported in the Part 1. The document is organised in three chapters. In Chapter 1, the Morphological Quality Index (MQI) and the Morphological Quality Index for monitoring (MQIm) have been applied to eight case studies. Chapter 2 presents the application of semi-automated procedures based on remote sensing datasets for monitoring and characterising channel forms to the River Orco (Italy). In Chapter 3, the Hydromorphological Evaluation Tool (HYMET) is applied to the Drau Ruver (Austria).

### **Acknowledgements**

REFORM receives funding from the European Union's Seventh Programme for research, technological development and demonstration under Grant Agreement No. 282656.

# Table of Contents

**Summary..... iii**

**1.Applications of MQI and MQIm to European case studies ..... 6**

1.1 Introduction ..... 6

1.2 The case studies ..... 7

1.3 Methods..... 8

1.3 Aurino River (Italy) ..... 10

    1.3.1. Study area ..... 10

    1.3.2. Results..... 11

1.4 Becva River (Czech Republic) ..... 13

    1.4.1. Study area ..... 13

    1.4.2. Results..... 15

1.5 Drau River (Austria)..... 18

    1.5.1. Study area ..... 18

    1.5.2. Results..... 20

1.6 Lippe River (Germany) ..... 22

    1.6.1. Study area ..... 22

    1.6.2. Results..... 25

1.7 Narew River (Poland) ..... 27

    1.7.1. Study area ..... 27

    1.7.2. Results..... 30

1.8 Thur River (Switzerland)..... 33

    1.8.1. Study area ..... 33

    1.8.2. Results..... 35

1.9 Töss River (Switzerland) ..... 37

    1.9.1. Study area ..... 37

    1.9.2. Results..... 39

1.10 Vaarajoki River (Finland) ..... 41

    1.10.1. Study area ..... 41

    1.10.2. Results..... 45

1.11 Results ..... 49

1.12 Discussion..... 52

1.13 Conclusions ..... 55

1.14	References .....	56
<b>2.</b>	<b>Application of remote sensing data for hydromorphological characterization</b> .....	<b>57</b>
2.1	Introduction .....	57
2.2	Study area and data .....	57
2.2.1.	The River Orco.....	57
2.2.2.	Classification framework: the Riverscape units.....	58
2.2.3.	The Orco Case study: data availability and classification objectives .....	60
2.2.4.	Geographical object-based image analysis (GEOBIA).....	61
2.2.5.	Multilevel Machine Learning (ML) classification of riverscape units.....	63
2.3	Classification Results.....	64
2.3.1.	Riverscape units classification results.....	64
2.4	Potential of the methodology for large scale (basin, regional) applications in Europe .....	68
2.5	Hydromorphological characterization of the River Orco.....	68
2.5.1.	Hydromorphological variables derivations.....	68
2.5.2.	Conclusions .....	73
2.5.3.	Linking the case study with Reform HYMO assessment methods and tools.....	74
2.6	References .....	75
<b>3.</b>	<b>The Hydromorphological Evaluation Tool (HYMET)</b> .....	<b>77</b>
3.1	Introduction .....	77
3.2	Evaluation - theory.....	78
3.2.1.	Catchment.....	78
3.2.2.	River Network .....	81
3.2.3.	River reach .....	85
3.3	Application .....	88
3.3.1.	Data collection .....	88
3.3.2.	Application - Sediment connectivity assessment .....	90
3.4	Summary .....	93
3.5	References .....	93

# 1. Applications of MQI and MQIm to European case studies

L. Nardi<sup>1</sup>, M. Rinaldi<sup>1</sup>, B. Belletti<sup>1</sup>, K. Brabec<sup>2</sup>, F. Comiti<sup>3</sup>, M. Giełczewski<sup>4</sup>, B. Golfieri<sup>5</sup>, S. Hellsten<sup>7</sup>, S. Kaufman<sup>6</sup>, E. Marchese<sup>3</sup>, P. Marcinkowski<sup>4</sup>, S. Muhar<sup>6</sup>, T. Okruszko<sup>4</sup>, A. Paillex<sup>8</sup>, M. Poppe<sup>6</sup>, J. Rääpysjärvi<sup>7</sup>, M. Schirmer<sup>8</sup>, M. Stelmaszczyk<sup>4</sup>, N. Surian<sup>5</sup>

<sup>1</sup>UNIFI, <sup>2</sup>MU, <sup>3</sup>Free University of Bozen-Bolzano, <sup>4</sup>WULS, <sup>5</sup>University of Padova, <sup>6</sup>BOKU, <sup>7</sup>SYKE, <sup>8</sup>EAWAG

## 1.1 Introduction

This chapter presents the results of the applications of the Morphological Quality Index (MQI) and the Morphological Quality Index for Monitoring (MQIm) to a series of European case studies.

The Morphological Quality Index (MQI) and the Morphological Quality Index for monitoring (MQIm) represent two novel tools for the hydromorphological assessment of streams specifically developed to fulfil the objectives of the Water Framework Directive 2000/60 (see Parts 1 and 3 of this Deliverable).

The application of the MQI to eight case studies selected within different biogeographical regions of Europe had the main objectives of:

1. Testing and enhancing the extended version which has been developed during the REFORM project to better represent those alterations and channel morphologies, such as lowland rivers with very low energy and anabranching, which were under-represented in the original version of the MQI, but can frequently be found in European in countries.
2. Analysing the hydromorphological response of the river to the various restoration measures.

Restoration measures were undertaken along all the selected rivers. For each river, a delineation in reaches was first carried out according to the procedure described in the D6.2 Part 1. Then, two reaches were selected for the application of the MQI and the MQIm, one including a restored site and the other representing a degraded condition. This was possible for most of the reaches, with the exception of the Töss River, for which an adjacent reach with comparable characteristics (in terms of confinement, degree of artificiality, etc.) was not available.

Then, the MQI and MQIm were both applied for all case studies to the pre-restoration vs. post-restoration conditions along the restored reach. The analyses of pre-restoration conditions were based on available material describing the reaches before any interventions, such as orthophotos.

## 1.2 The case studies

Seven rivers selected among the case studies of the REFORM Work Package 4 (Kail et al., 2014), with the addition of the Aurino River, were analysed. All the eight case studies included restoration measures, and were selected within different biogeographical regions of Europe in order to represent a sufficiently wide range of physical conditions. The main characteristics of the case studies are summarised in Table 1.1, whereas their location is presented in Figure 1.1.

The analysed reaches were delimited according to the REFORM multiscale, delineation framework (see section 1.3). Reach length ranges from a minimum of 1.16 km (Aurino) to a maximum of 5.85 km (Vääräjoki). Most of the investigated reaches are unconfined; bed slope ranges from 0.02% (Narew) to 0.5% (Thur and Töss); bed sediment ranges from sand to boulders; channel morphologies include straight, sinuous, meandering, wandering and anabranching types. The restored length in Table 1.1 is expressed both in km and as the percentage of the restored portion over the total reach length (in the case of anabranching channels, the total reach length is the sum of the length of all the anabranches). This ranges from a minimum of 4.4% (Töss) to a maximum of 100% (Aurino).

Different restoration measures have been undertaken (Table 1.2), which include removal of bank protections and/or artificial levées, channel widening, reconnection or construction of secondary channels and instream measures for habitat enhancement. Introduction of large wood along the Lippe River, and bed level raising by the re-introduction of sediment along the Aurino River were carried out in combination with some of the previous measures. One particular case is that of the Becva River: here, removal of bank protections and channel widening occurred in response to an intense flood event in 1997, so restoration consisted of leaving the channel morphology and not fixing the banks again.



Figure 1.1 Location of the selected rivers.

**Table 1.1 Main characteristics of the selected rivers. Catchment size, mean discharge (Q<sub>mean</sub>), altitude, bed sediments, confinement and channel morphology refer to the restored reach.**

River name	Aurino	Becva	Drau	Lippe	Narew	Thur	Töss	Vääräjoki
Country	I	CZ	A	D	PL	CH	CH	SF
Altitude (m a.s.l.)	840	232	570	72	139	371	453	60
Catchment (km <sup>2</sup> )	629	1532	2433	1896	3680	1605	188	835
Bed slope (%)	0.1	0.2	0.14	0.05	0.02	0.5	0.5	0.13
Bed sediment	G	G	G	S	S	G	G	B
Confinement	PC	U	U	U	U	U	PC	U
Morphology	M	S	W	S	A	W	St	S
Q <sub>mean</sub> (m <sup>3</sup> /s)	20	16.6	62.6	17.7	16.9	52.9	9.9	9.9
Restoration Length (km)	1.19	0.45	1.9	2	4.6	1.55	0.21	1.4
Restoration Length (%)	100	22.1	97.4	85.5	29.2	87.6	4.4	23.9
Restoration date	2007-2010	1997	2002-2003	1996-1997	Since 1995	2002	a) 1999 b) 2010	1997-2006

Bed Sediment: G=Gravel, S= Sand, B= boulder, blocks, cobbles; Morphology: St=Straight, S=Sinuous, M=Meandering, W=wandering, A=Anabranching; Confinement: U=unconfined, PC= Partially confined

**Table 1.2 Main restoration measures undertaken at the selected reaches.**

River	Restoration date	Main restoration measure
Drau	2002-2003	Partial removal of bank fixation; initiation of secondary channel; reconnection of one sidearm
Thur	2002	Enhancement of flood protection and biota diversity, removal of embankments
Becva	1997	Removal of bank fixation
Vääräjoki	1997-2006	Instream measures
Lippe	1996-1997	Removal of bank protections and levees, channel widening, bed level raising, introduction and fixation of dead wood
Narew	Since 1995	Reconnection side channels (rise water level by submerged sills) and removal of excess of sediment and vegetation)
Töss	a)1999 b)2010	Enhance biota diversity, remove embankments
Aurino	2007-2010	Removal of bank fixation; widening; initiation of secondary channel; bed level aggradation

### 1.3 Methods

The analysis of the selected reaches of the different case studies was undertaken according to the guidelines reported in Rinaldi et al., 2015 (Deliverable D6.2 Part 3). It was carried out in two phases. The first phase concerned the delineation of reaches and other relevant spatial units; the second phase concerned the calculation of the MQI and MQIm index. The first phase of delineation of spatial units included 4 consecutive steps, according to the procedure defined by Rinaldi et al. (2013) which is fully consistent with the REFORM multi-scale, delineation framework (Gurnell et al. 2014, 2015): (1)



delineation of landscape units based on catchment scale characteristics, such as geology, topography and land use; (2) delineation of segments by also taking into account the general characteristics of the valley setting and major hydrological discontinuities; (3) a first delineation of reaches on the basis of the valley setting and channel morphology; (4) final delineation of reaches on the basis of other elements of discontinuity (e.g. minor tributaries, artificial elements, presence of morphological units, etc.).

The confinement index and degree as well as the indexes of channel pattern morphology (i.e. sinuosity and anabranching index) were calculated in order to characterise and define the reaches.

Once defined and selected representative reaches for each case study, the Morphological Quality Index (MQI) and the Morphological Quality Index for monitoring (MQIm) were calculated. Specifically, two reaches were chosen for each case study one representing a degraded condition and the other including restoration measures. The Töss represents an exception. In fact, given the short extent of the restoration measures, it was not possible to distinguish a restored reach having a meaningful morphological length, and an adjacent reach with comparable characteristics (in terms of confinement, degree of artificiality, etc.) was not available. Thus, only one reach was selected along the Töss River.

The MQI and the MQIm have been specifically developed to assess the morphological quality of the river, and to evaluate and monitor the impacts on the morphological quality of interventions, including restoration projects, respectively.

The MQI evaluation procedure consists of a set of 28 indicators which allow for the assessment of the longitudinal and lateral continuity, channel pattern, cross section configuration, bed structure and substrate, and vegetation in the riparian corridor. These characteristics are analysed in terms of geomorphological functionality, artificiality, and channel adjustments.

A scoring system is used in the MQI, obtained through classes ranging from A indicating absence of alteration, to C associated to a maximum degree of alteration. Reference conditions are identified with a river reach in dynamic equilibrium, performing those morphological functions that are expected for a specific morphological typology, and where artificial elements and pressures are absent or do not significantly affect the river forms and processes. The final score ranges from 0 (worst conditions) to 1 (reference conditions).

The MQIm is based on the same indicators of the MQI, although the indicators of channel adjustments are not included in the calculation. A scoring system is also used in the MQIm, however instead of discrete classes, the scores of many indicators are based on continuous mathematical functions. This allows the MQIm to be more sensitive to changes occurring at a temporal scale of a few years, as required for monitoring purposes, and is particularly suitable for the environmental impact assessment of interventions, including restoration measures (Rinaldi et al., 2015).

The overall MQI and MQIm evaluations were carried out by making a synergic use of two GIS analysis and field surveys. In particular, existing material at reach scale was examined, including: (i) the most recent remote sensed images representing the current river conditions; (ii) historical aerial photos (when available); (iii) map layer of interventions (when available), including information on relevant structures responsible for the alteration of flows and/or bedload interception in the sub-catchment upstream from the reach. After a preliminary remote sensing – GIS analysis, a field survey was carried out in the period May 2014 – September 2014 for all investigated reaches followed by the GIS analysis and the measurement of quantitative parameters.

## 1.3 Aurino River (Italy)

### 1.3.1. Study area

The Aurino River basin has a drainage area of 629 km<sup>2</sup> and is located in South Tyrol, Italian Alps. The Aurino River, with its 53 km of length and 15.2 m<sup>3</sup>s<sup>-1</sup> of annual mean water discharge (30–50 m<sup>3</sup>s<sup>-1</sup> during the summer), is the most important tributary of the Rienz/Rienza River. The river segment analysed here lies in the lower, wider Ahr valley, where the channel features mostly partly confined conditions punctuated by debris flow fans determining shorter confined reaches. Gravel mining occurred in this river stretch from the 1950s to the 1980s. Bed incision became evident during the second half of the twentieth century, leading to a morphological and hydrological discontinuity between the channel and its floodplain, the latter being now a terrace flooded only by events with recurrence intervals >30–50 years, depending on the location. Bed incision has also caused a lowering of the water table, probably limiting the growth and dynamics of riparian forest dominated by grey alder (*Alnus incana*) but certainly favouring conditions for agriculture and bed armouring. In 2003 the Department of Hydraulic Engineering of the Autonomous Province of Bolzano started a river restoration program with the purpose of improving the ecological functionality of the river. The river restoration program consists mainly of the removal of river bank protections, channel widening, raising of the riverbed by introducing the sediments taken from the banks, and creation of islands (Figure 1.2). The restored reach (partly confined) is located near the village of Gais (about 1100 m in length, average slope of 0.1%). The current channel width is about 60 m, and the channel pattern is sinuous (Table 1.3).

The MQI assessment was carried out with reference to the years 2000 (pre-restoration) and 2013 (post-restoration). The application to the year 2000 was possible thanks to orthophotos, reports, and cross sections available for that year.

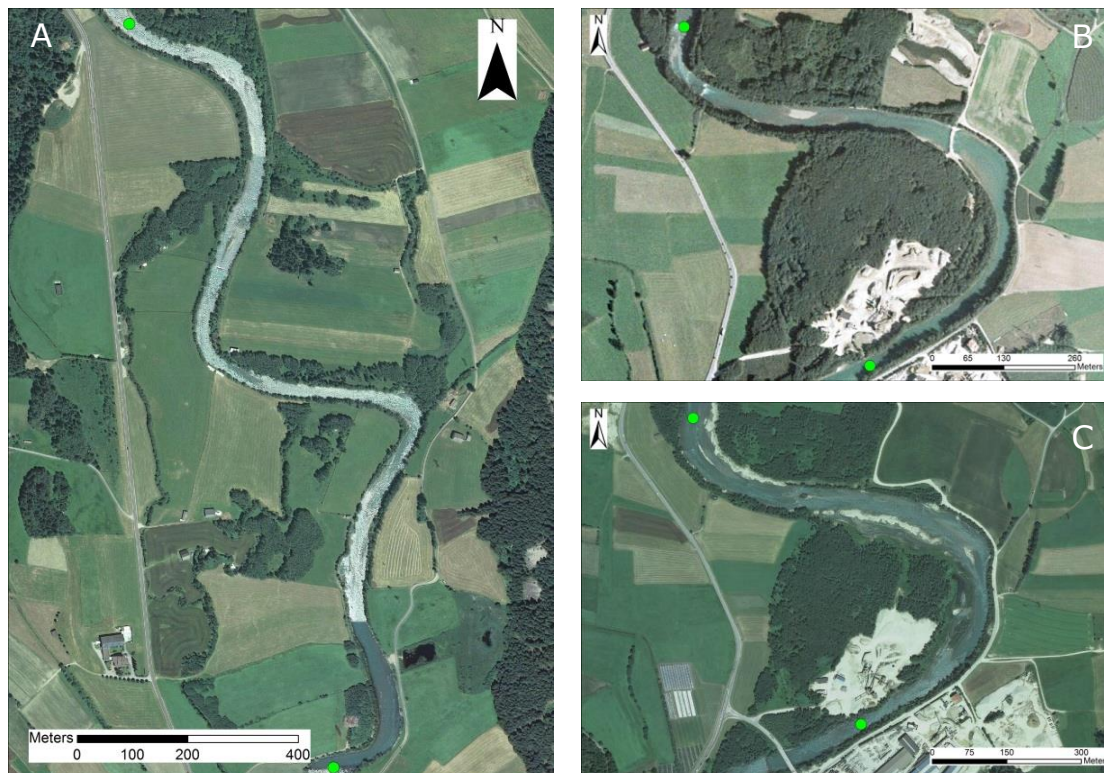

**Figure 1.2** Aurino River, view of the degraded reach (2011) and pre-restored reach(2000) in A and B, respectively. C: Aerial photo of the Restored reach of the Aurino River (Province of Bolzano, Orthophoto 2011).

**Table 1.3 Aurino River: main characteristics of the study reaches.**

Reach	Length (m)	Channel width (m)	Morphology	Confinement	Qmean (m <sup>3</sup> /s)	Q1.5 (m <sup>3</sup> /s)
Before restoration	1165	35	Meandering	PC	15,2	50
After restoration	1165	61	Meandering	PC	15,2	50

**1.3.2. Results**

The MQI and the MQIm have been calculated in order to assess and monitor the morphological condition of the Aurino river where restoration measures have been undertaken.

The morphological condition before the restoration was moderate (MQI= 0.54) as a result of a discontinuous and narrow floodplain and riparian vegetation, lack of riverbank processes and variability of the cross sections, as well as an altered bed structure and absence of large wood in the channel as showed by the class (C) of the corresponding MQI indicators in Table 1.4. Artificialities were also present before the restoration, with the worst being the removal of sediments from the channel (A10 is in class C). These results are in line with the negative judgement that led to the decision to carry out restoration work in this river segment (Campana et al., 2014).

The morphological quality of the current restored reach, represented in Figure 1.3, resulted as being good (MQI=0.73).



**Figure 1.3 Aurino River: The upper part of the restored reach viewed from upstream to downstream (A, B and C) and the lower part viewed from downstream to upstream (D).**

The indicators of functionality relative to lateral continuity (F2 and F4) and channel morphology (F7 to F10) and indicators of artificiality (A5–A6) also improved as, here, bank protections were removed during the work, along with a bridge. Moreover, some indicators passed from the lowest (class C) to the highest score (class A) after the restoration. In fact, restoration measures described in the Section 1.3.1 improved the functionality of the reach, by promoting the bank erosion processes and the development of morphological features (bars and island) and favouring the variability of the cross sections and the natural heterogeneity of the natural bed structures. The effects of the restoration can be observed by comparing the classes of the MQI indicators before and after the restoration (Table 1.4) and evaluated in Figure 1.3.

**Table 1.4 Aurino River: summary of the MQI indicators for the restored reach before (BR) and after the restoration (AR).**

Indicator	Degraded	Before restoration	After restoration
<b>FUNCTIONALITY</b>			
F1	A	A	A
F2	C	C	B2
F4	C	C	B
F5	B	B	B
F7	B	B	A
F8	Not evaluated	B	B
F9	C	Not evaluated	Not evaluated
F10	C1	C1	A
F11	C	C	A
F12	C	C	C
F13	C	C	B
<b>ARTIFICIALITY</b>			
A1	A	A	A
A2	B1	B1	B1
A3	A	A	A
A4	A	A	A
A5	A	B	A
A6	C	B	A
A7	A	A	A
A8	A	A	A
A9	A	B	B
A10	A	C	C
A11	B	B	B
A12	B	B	B
<b>CHANNEL ADJUSTMENTS</b>			
CA1	Not evaluated	Not evaluated	Not evaluated
CA2	Not evaluated	Not evaluated	Not evaluated
CA3	Not evaluated	Not evaluated	Not evaluated
<b>SCORE AND CLASS</b>			
<b>MQI</b>	0.59	0.54	0.73
<b>CLASS</b>	MODERATE	MODERATE	GOOD

As the method was not originally designed to be applied to cases where restoration work had recently been implemented, the MQI was also applied without responding to the channel adjustment indicators (the method permits this option) in order to make the pre-post restoration assessments comparable.

The comparison of the MQIm values before and after the restoration confirms a positive trend in the morphological quality of the reach (Table 1.5).

**Table 1.5 Aurino River: summary of the MQIm indicators for the restored reach before and after the restoration.**

Indicator	Before restoration	After restoration
<b>FUNCTIONALITY</b>		
F1m	0	0
F2m	4.40	4.40
F4m	3.50	2.50
F5m	2.50	2.50
F7m	3.55	1.20
F8m	2.50	2.50
F9m	Not evaluated	Not evaluated
F10m	6.50	0
F11m	3.50	0
F12m	2.14	2.52
F13m	5.78	5.73
<b>ARTIFICIALITY</b>		
A1m	0	0
A2m	4.50	4.50
A3m	0	0
A4m	0	0
A5m	2	0
A6m	4.50	0
A7m	0	0
A8m	0	0
A9m	3.31	3
A10m	7.50	4.50
A11m	3.50	3.50
A12m	3.50	3.50
<b>SCORE</b>		
MQIm	0.67	0.79

## 1.4 Becva River (Czech Republic)

### 1.4.1. Study area

The Becva River is one of the main tributaries of the Morava River (Czech Republic). The river is 61.6 km long with its river basin extending to 1613 km<sup>2</sup> (Figure 1.4). The flow rate is highly fluctuating due to small retention capacity of the basin where bedrock prevails. The water reaches the highest level during the spring and the lowest during September. From the end of the 19<sup>th</sup> century, interventions were implemented in order to regulate the water flow. In the early twentieth century, the river was altered, shortening meanders and smoothing the channel.

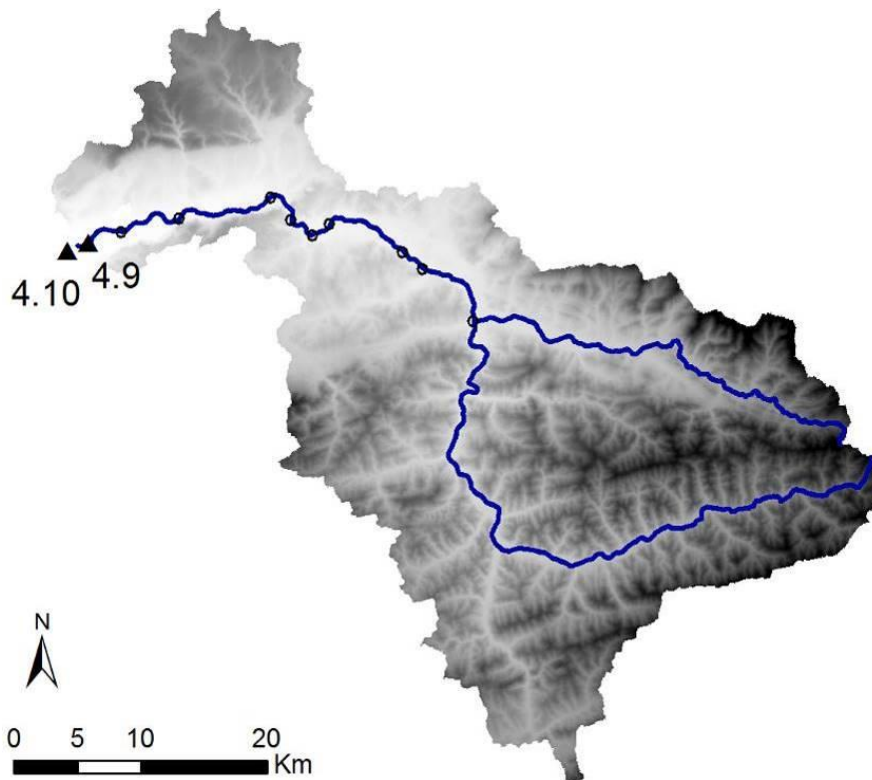

**Figure 1.4 Becva catchment**

Two contiguous reaches were selected for the application of the MQI and MQIm: a degraded and a restored one. The catchment area at the restored reach is 1243 km<sup>2</sup>. Similarly to the entire Becva River, at the degraded reach the natural braided channel pattern and the high dynamics of the gravel-bed channel were altered by a channelisation project occurred in the period 1902-1935. At this reach the channel width is almost constant (about 34 m) and no morphological features are present. Instead, the restored reach has a wider channel (about 47 m) characterised by the presence of morphological features such as side bars. Erosional and depositional processes can also be observed, as well. The Becva river represents a case where restoration occurred 'naturally' following the flood in 1997, and concerns a river length of about 700 m. The 1997 flood promoted channel widening and the development of morphological features by removing bank protections. Subsequently, the flood bank protections and other interventions were not rebuilt. In this sense the channel was naturally restored. The effects of the natural restoration can be noted by comparing Figure 1.6A and Figure 1.6B.

Segmentation of the reaches along the Becva River was carried out based on the delineation procedure described in the D6.2 Part 1. Aerial photos acquired in 2010 ([geoportal.cuz.k.cz](http://geoportal.cuz.k.cz)) were analysed in ArcGis to define the limits of the study reaches together with the land use map (Corine Land Cover 2006 of level 1), the DEM and the geological map. Aerial photos from 2010 together with historical maps from 1950 were also used to measure the channel width and sinuosity and to conduct the remote-sensing analysis that is required to evaluate a set of MQI and MQIm indicators. The indicators measured by remote-sensing were later verified during the field surveys carried out in the period June 15th to 19th 2014.

The selected reaches are included in a hilly physiographic setting. Due to the confinement index and confinement degree both reaches resulted as being unconfined (Figure 1.5). The presence of a weir with a diversion, having important effects on the flow and sediment discharges represents the upstream limit of the degraded reach,

whereas the presence of a ramp representing a longitudinal disconnection is the upstream limit of the restored reach.

The degraded reach has a length of 3001.4 m, an average channel width of about 34 m, and it presents straight channel morphology, having a sinuosity index of 1.03. The restored reach, which included the restoration site having a length of approximately 700 m, is about 2041 m long and 47 m wide on average (Table 1.6).

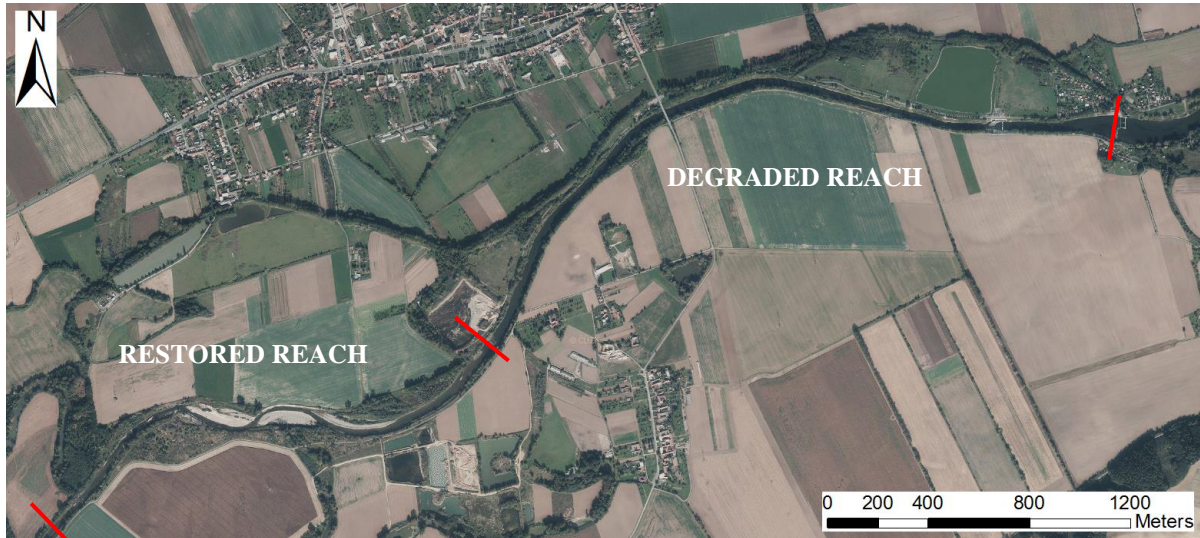

**Figure 1.5** Aerial photo of the Becva River, including both the degraded and restored reaches (WMS geoportal.cuz.k.cz, 2010).

**Table 1.6** Becva River: main characteristics of the study reaches.

Reach	Length (m)	Channel width (m)	Morphology	Confinement	Q <sub>mean</sub> (m <sup>3</sup> /s)	Q <sub>1.5</sub> (m <sup>3</sup> /s)
Degraded	3001.4	33.9	Straight	Unconfined	16.6	239
Restored	2041.1	46.9	Sinuous	Unconfined	16.6	239



**Figure 1.6** Becva River, view of the degraded reach and restored reaches in A and B, respectively.

**1.4.2. Results**

The application of the MQI allowed for the assessment of the morphological quality of the reaches in the current condition and before the restoration in case of the restored reach (Table 1.7).

In the current condition, the morphological quality of the degraded reach is 'poor', the MQI value being equal to 0.34. This is the result of a very low functionality of the reach (all the indicators are in class C, with the exception of F13) due to the absence of floodplain and morphological processes, as well as to a negligible variability of cross sections and of the presence of in-channel large wood and a very narrow and only partially functioning width of riparian vegetation. The poor functionality of the reach is in turn strictly linked to the presence of artificialities and in particular to the continuous presence of bank protections (A6) and the presence of a diversion upstream from the reach, which affects the flow discharges and intercepts sediments (A1, and A2, Figure 1.7).



**Figure 1.7** Diversion at the upstream limit of the degraded reach.

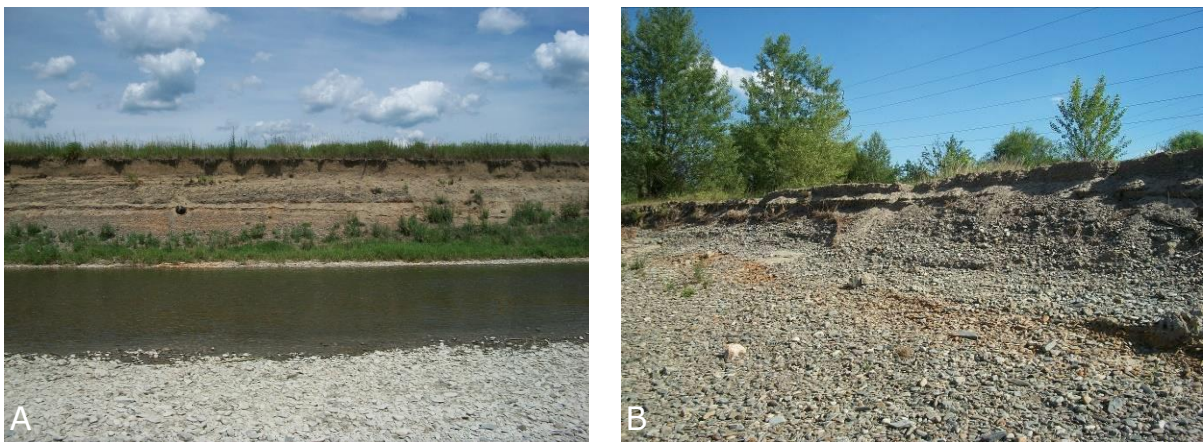

**Figure 1.8** Eroding bank (A) and heterogeneity of bed sediments (B) at the restored reach.

The current condition of the degraded reach is not dissimilar to the condition of the restored reach before the occurrence of the flood in 1997. Also in this case, the morphological quality is classed as 'poor', with the MQI value equal to 0.34 as in the previous case (Table 1.7). In fact, the restored reach before the restoration, was affected by the same impacts which can be found at present in the degraded reach and which are responsible for a very low functionality. Similarly to the current degraded reach, banks were fully protected and according to the former river management, sediments and woods were removed from the channel for flood protection purposes.

The destruction of bank protection due to the flood in 1997 improved the functionality of the restored reach by promoting processes of bank retreat (F4, Figure 1.8A) and therefore the natural heterogeneity of bed sediments (F10, Figure 1.8B), as well as a



variability of the cross sections, due to the presence of bars (Figure 1.6B). The removal of bank protection also allowed for a widening of the potentially erodible corridor (F5).

After the flood management policies at this reach changed and the removal of sediments and woods was less intense (A10 and A11).

**Table 1.7 Becva River: summary of the IQM indicators for the degraded and restored reach before (BR) and after the restoration (AR).**

Indicator	Degraded	Restored (BR)	Restored (AR)
<b>FUNCTIONALITY</b>			
F1	C	C	B
F2	C	C	B2
F4	C	C	A
F5	C	C	A
F7	C	C	C
F8	Not evaluated	Not evaluated	Not evaluated
F9	C	C	B
F10	Not evaluated	Not evaluated	A
F11	C	C	B
F12	C	C	B
F13	B	A	A
<b>ARTIFICIALITY</b>			
A1	C	C	C
A2	B2	B2	B2
A3	A	A	A
A4	B	A	A
A5	B	A	A
A6	C+penalty	C+penalty	B
A7	A	A	A
A8	A	B	B
A9	B	B	B
A10	C	C	B1
A11	B	C	B
A12	B	B	B
<b>CHANNEL ADJUSTMENTS</b>			
CA1	A	A	no
CA2	A	A	no
CA3	B	C1	C1
<b>SCORE AND CLASS</b>			
<b>IQM</b>	0.34	0.34	0.58
<b>CLASS</b>	POOR	POOR	MODERATE

The reduction of artificialities and the resulting improvement of the functionality which occurred with the flood were quite important, to the extent that the MQI changed from the class 'poor' to the class 'moderate'.

The application of the MQIm to the restored reach before and after the restoration amplifies what was already observed during the application of the MQI. In this case the difference between the scores resulting from the two applications is quite important, increasing from 0.46 to 0.7 before and after the restoration, respectively (Table 1.8).

**Table 1.8 Becva River: summary of the IQMm indicators for the restored reach before and after the restoration.**

Indicator	Before restoration	After restoration
<b>FUNCTIONALITY</b>		
F1m	6	4
F2m	6	3.21
F4m	3.5	0
F5m	3.5	0.5
F7m	6	4.51
F8m	Not evaluated	Not evaluated
F9m	6	3.29
F10m	Not evaluated	0
F11m	3.5	2.5
F12m	2.82	1.72
F13m	0.9	0.9
<b>ARTIFICIALITY</b>		
A1m	7.5	7.5
A2m	9.32	9.32
A3m	0	0
A4m	0	0
A5m	0	0
A6m	21	3.08
A7m	0	0
A8m	2.5	2.5
A9m	3	3
A10m	7.5	4.5
A11m	6.5	3.5
A12m	3.5	3.5
<b>SCORE</b>		
IQMm	0.46	0.7

## 1.5 Drau River (Austria)

### 1.5.1. Study area

The Drau is a river in southern Central Europe, a tributary of the Danube. It sources in Italian South Tyrol, flows eastwards through East Tirol and Carinthia in Austria into Slovenia for 142 kilometres and then southeast, passing through Croatia and forming most of the border between Croatia and Hungary, before it joins the Danube near Osijek.

Two reaches were selected along the Drau River, one representing a degraded condition and the second which includes a restoration site.

The degraded reach, which is limited upstream and downstream by the confluence with tributaries, is approximately 5200 m long. Its average channel width is 49 m, and it presents a sinuous channel morphology, having a sinuosity index of 1.13 (Table 1.9).

The restored reach is located near the village of Klebach in Carinthia (Figure 1.9). Here the Drau catchment is roughly 2500 km<sup>2</sup>, and the average annual flow of the river is 70m<sup>3</sup>/s. The reach is about 1950 m long and 90 m wide on average (Table 1.9). Its morphology can be defined as straight with local wandering. The current morphology and channel width are the results of restoration measures which started in 2002.

Interventions included the removal of stabilisation structures over a length of 1.3 km bank and the widening of the channel up to 45 m in several sections. A second side arm was also created with a length of 500 m and a width of 30 m (Figure 1.10). Furthermore, the project consisted of initial plantings of additional floodplain forests, the establishment of new water bodies in the floodplains, the reintroduction of highly endangered or lost plant and animal species, as well as various other protective measures for endangered species.



**Figure 1.9** Aerial photo of the Drau River, at the degraded (A) and restored (B) reaches (WMS gis.ktn.gv.at, 2011).

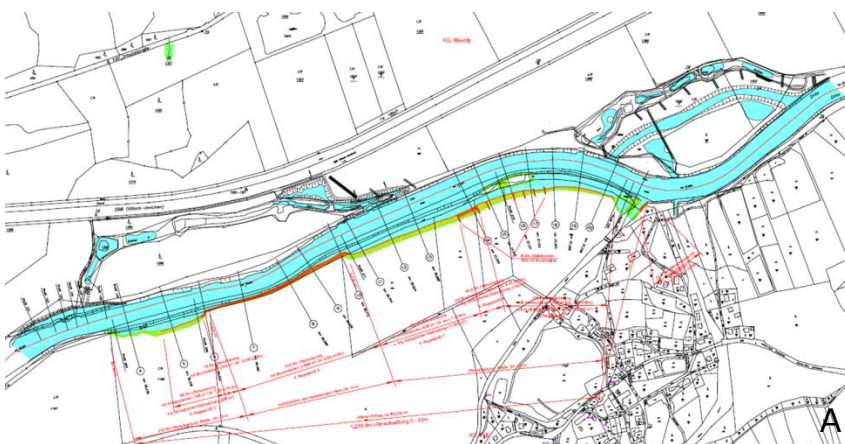

**Figure 1.10** Drau River, view of the restoration project and the restored reach in A and B, respectively.

**Table 1.9 Drau River: main characteristics of the study reaches.**

Reach	Length (m)	Channel width (m)	Morphology	Confinement	Qmean (m <sup>3</sup> /s)	Q1.5 (m <sup>3</sup> /s)
Degraded	5184	49	Sinuuous	U		n.a
Restored (Br)	1954	50	Straight	U	69.8	n.a
Restored (Ar)	1954	90	Wandering	U	69.8	n.a

ArcGIS analyses based on images from 2011 (WMS gis.ktn.gv.at, 2011) were used to define the limits of the study reaches, to measure channel width and to conduct the remote-sensing analysis that is required to evaluate a set of MQI and MQIm indicators. A field survey carried out during the summer of 2014 was necessary to evaluate those indicators which could not be estimated through remote sensing as well as to check the preliminary remote sensing – based results.

### 1.5.2. Results

In the current condition, the morphological quality of the degraded reach is 'moderate', the MQI value being equal to 0.50.

This is the result of a low functionality of the reach mainly due to the continuous presence of bank protections (A6 has the maximum penalty). The latter are, in fact, responsible for a negligible presence or absence of floodplain, riverbank processes, potentially erodible corridor as well as a consistent presence of alteration of the morphological pattern (F2, F4, F5, F7 are in class C), as described in Table 1.10.

The current condition of the degraded reach is very similar to the condition of the restored reach before the measure of restoration started. This measure resulted in a moderate morphological condition, although the MQI value is higher (0.55), due to the absence of crossing structures (A5) and a wider and more extended functional vegetation (F12 and F13).

In the years from 2002 to 2003 several restoration measures were implemented over a total length of 1.9 km. The effect of the removal of bank protections improved the functionality of the reach by promoting riverbank erosional processes as well as the development of morphological features (Figure 1.11). These effects were captured by both the MQI and MQIm indicators (F4, F7, F9 and the corresponding F4m, F7m, F9m in Table 1.10 and

Table 1.11). Due to the restoration measures, the morphological quality of the reach increased to good.

**Table 1.10 Drau River: summary of the MQI indicators for the degraded and restored reach before (BR) and after the restoration (AR).**

Indicator	Degraded	Restored (BR)	Restored (AR)
<b>FUNCTIONALITY</b>			
F1	A	A	A
F2	C	C	C
F4	C	C	B
F5	C	C	C
F7	C	C	B
F8	Not evaluated	Not evaluated	Not evaluated
F9	C	C	A
F10	Not evaluated	Not evaluated	A
F11	A	A	A
F12	C	B	B

Indicator	Degraded	Restored (BR)	Restored (AR)
F13	B	A	A
<b>ARTIFICIALITY</b>			
A1	A	A	A
A2	B1	B1	B1
A3	A	A	A
A4	A	A	A
A5	B	A	A
A6	C + penalty	C + penalty	C
A7	A	A	A
A8	A	A	A
A9	A	A	A
A10	B1	B1	B1
A11	A	A	A
A12	B	B	B
<b>CHANNEL ADJUSTMENTS</b>			
CA1	Not evaluated	Not evaluated	Not evaluated
CA2	Not evaluated	Not evaluated	Not evaluated
CA3	Not evaluated	Not evaluated	Not evaluated
<b>SCORE AND CLASS</b>			
<b>IQM</b>	0.50	0.55	0.75
<b>CLASS</b>	Moderate	Moderate	Good

**Table 1.11 Drau River: summary of the MQIm indicators for the degraded and restored reach before and after the restoration.**

Indicator	Before Restoration	After Restoration
<b>FUNCTIONALITY</b>		
F1m	0	0
F2m	6.00	6.00
F4m	3.50	2.50
F5m	2.50	2.50
F7m	6.00	4.00
F8m	Not evaluated	Not evaluated
F9m	6.00	1.49
F10m	Not evaluated	Not evaluated
F11m	2.50	0
F12m	2.32	2.32
F13m	0	0
<b>ARTIFICIALITY</b>		
A1m	0	0
A2m	0	0
A3m	0	0
A4m	0	0
A5m	0	0

Indicator	Before Restoration	After Restoration
A6m	21.00	5.56
A7m	0	0
A8m	0	0
A9m	0	0
A10m	4.50	4.50
A11m	0	0
A12m	3.50	3.50
<b>SCORE</b>		
IQMm	0.69	0.82

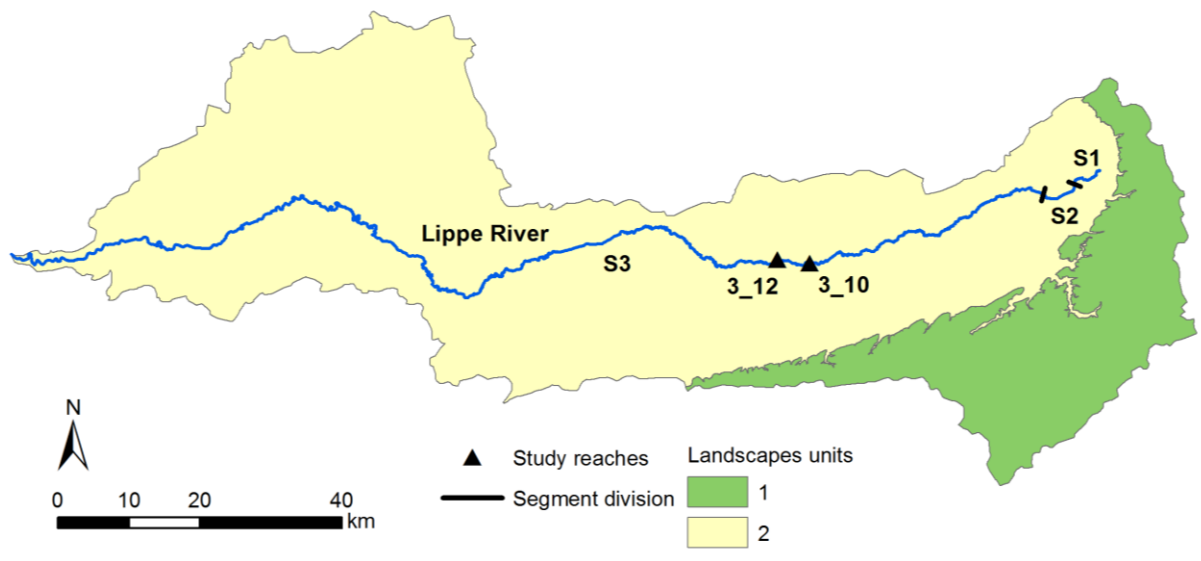

**Figure 1.11** Drau river at the restored (A) and degraded (B) reaches.

## **1.6 Lippe River (Germany)**

### **1.6.1. Study area**

The Lippe River drains from the mountains and hills of central-western Germany and is a tributary of the Rhine River. The length of Lippe River is 255 km and its catchment is 4882 km<sup>2</sup>. The catchment is dominated by glacial and aeolian deposits and by Cretaceous limestones. Two landscape units can be delineated within the Lippe catchment: a large lowland area that is covered by cultivated, urban and industrial areas and a smaller hilly and mountain unit, that is located in the eastern and south-eastern portion of the catchment, mainly covered by forests. According to the procedure summarized in Section 1.3, the Lippe River was delineated into 3 segments based on the geology and the presence of major tributaries. Changes of channel morphology and other longitudinal discontinuities were used to define the reaches (Figure 1.12).



**Figure 1.12 Lippe catchment: delineation of landscape units and segments (codes from S1 to S3). Landscape units: (1) mountain and hilly areas, (2) lowland areas.**

The two study reaches are located in the floodplain between the villages of Benninghausen and Herzfeld. They both present a sinuous channel morphology, low channel slope (i.e. about 0.03%) and sandy substrate (Figure 1.13); catchment size at their downstream extremity is 1896 km<sup>2</sup>. Delimitation of the upstream study reach was defined based on a significant change of channel width (i.e. 34 m vs. 18-20 m) in respect to the contiguous reaches.



**Figure 1.13 Satellite image of the Lippe River, including both the degraded and restored reach.**

The upstream study reach (segmentation code 3\_10) underwent a series of restoration interventions between 1996 and 1997. The continuous bank protections and the levees, that were present along the left bank, were completely removed and the channel width was increased from about 18 m up to 34 m (Figure 1.14 and Table 1.12). Sediment was added into the channel to raise the bed by 2 m and to reconnect the river, both in terms of hydraulic and morphological processes, with its former floodplain. A ramp was built at the downstream end of the reach to prevent channel incision. In addition, several trunks

were fixed within the channel and on the banks, to enhance microhabitat diversity (Figure 1.15).

The morphological conditions of the downstream study reach (segmentation code 3\_12) are similar to those that were present in the restored reach before the restoration interventions (Figure 1.14 and Table 1.12). Both banks are almost completely fixed by bank protections and a modern floodplain is absent, since the channel underwent a moderate incision. Riparian vegetation is limited to a narrow strip of trees along the banks. Delimitation of the degraded study reach was based on a significant reduction of channel width in respect to the upstream reach (12 m vs. 20 m), while downstream extremity was placed in correspondence with a change in channel sinuosity.



**Figure 1.14** Lippe River, view of the degraded reach (A) and restored reach (B).

**Table 1.12 - Lippe River: main characteristics of the study reaches.**

Reach	Length (m)	Channel width (m)	Morphology	Confinement	$Q_{\text{mean}}$ ( $\text{m}^3/\text{s}$ )	$Q_2$ ( $\text{m}^3/\text{s}$ )
Degraded	3397	12	Sinuuous	U	17.7	113
Restored	2282	34	Sinuuous	U	17.7	113



**Figure 1.15** Upstream restored reach: one of the trunks that were fixed in the channel and on the banks, to enhance microhabitat diversity.

ArcGIS basemap images (acquisition in September 2012) were used to define the limits of the study reaches, to measure channel width and sinuosity and to conduct the remote-sensing analysis that is required to evaluate a set of MQI indicators. Historical



maps of the period 1891-1912 at 1:25000 scale (available on-line at the Nordrhein Westfalen Region geoportal, <http://tim-online.nrw.de>), were used to evaluate adjustments in channel pattern (i.e. indicator CA1). Since historical aerial photographs were not available and the resolution of the above mentioned maps was low, adjustments in channel width (CA2) were not evaluated. The presence of artificial structures in the upstream catchment (i.e. weirs and check dams) and in the study reaches (i.e. bank protections, levees, ramps) was evaluated referring to two databases, one for medium-large rivers and the other for small rivers, collated by the Nordrhein Westfalen Region. The presence of artificial structures in the study reaches was also checked in the field during the survey that was carried out in September 2014.

### 1.6.2. Results

The downstream degraded reach presents moderate morphological conditions (i.e. MQI value = 0.56) (Table 1.13). The main impacts are related to the widespread presence of bank protections (A6 indicator) and the complete absence of modern floodplain areas (F2 indicator). The potential erodible corridor is extremely limited (F5 indicator) and the outcrop of the marl bedrock (F10 indicator) can be observed at some sites along the reach, since a process of incision has occurred over the last decades (CA3 indicator).

The morphological conditions of the upstream reach before the interventions of restoration were almost equal (i.e. MQI value = 0.55) to the conditions of the actual degraded reach. The interventions of restoration caused a marked improvement of the MQI value (i.e. from 0.55 to 0.74), with a change from moderate to good morphological status. The improvement is related to the widespread removal of bank protections (A6 indicator) and levees (A7 indicator). The potential erodible corridor therefore became wide and continuous (F5 indicator) and the input of sediments in the channel allowed the reconnection with the former floodplain (F2 indicator).

**Table 1.13 Lippe River: summary of the MQI indicators for the degraded and restored reach before (BR) and after the restoration (AR).**

Indicator	Degraded	Restored (BR)	Restored (AR)
<b>FUNCTIONALITY</b>			
F1	A	A	A
F2	C	C	A
F4	Not evaluated	Not evaluated	Not evaluated
F5	C	C	A
F7	B	A	A
F8	Not evaluated	Not evaluated	Not evaluated
F9	Not evaluated	Not evaluated	Not evaluated
F10	C1	Not evaluated	Not evaluated
F11	C	C	C
F12	C	A	B
F13	B	C	C
<b>ARTIFICIALITY</b>			
A1	B	B	B
A2	B1	B1	B1
A3	A	A	A
A4	A	A	A
A5	A	B	B
A6	C + penalty	C + penalty	B
A7	A	B	A

Indicator	Degraded	Restored (BR)	Restored (AR)
A8	A	A	A
A9	A	A	B
A10	A	A	A
A11	A	A	A
A12	B	C	C
<b>CHANNEL ADJUSTMENTS</b>			
CA1	A	A	Not evaluated
CA2	Not evaluated	Not evaluated	Not evaluated
CA3	B	B	A
<b>SCORE AND CLASS</b>			
<b>MQI</b>	0.56	0.55	0.74
<b>CLASS</b>	MODERATE	MODERATE	GOOD

The application of the MQIm underlines a significant improvement of the morphological conditions before and after the interventions of restoration (Table 1.14). The MQIm values varied from 0.66 to 0.82. Only two indicators changed negatively: A9m due to the construction of a ramp and F12m because of the decreased ratio between functional vegetation and channel width. The latter markedly increased as mentioned in 1.9.1 paragraph, while the width of functional vegetation remained the same, since the vegetation that is present in the reconnected floodplain is predominantly composed of poplar plantations (i.e. semi-functional vegetation). The evaluation of all the other indicators remained the same or varied positively and it is worthwhile noting the substantial changes of A6m (from 21.00 to 1.67), related to the widespread removal of bank protections, F2m (from 6.00 to 1.16) due to floodplain reconnection, A7m (from 3.87 to 0) due to removal of levees and F5m (from 3.50 to 0.22) due to the widening of the erodible corridor.

**Table 1.14 Lippe River: summary of the MQIm indicators for the degraded and restored reach before and after the restoration.**

Indicator	Before restoration	After restoration
<b>FUNCTIONALITY</b>		
F1m	0	0
F2m	6.00	1.16
F4m	Not evaluated	Not evaluated
F5m	3.50	0.22
F7m	0	0
F8m	Not evaluated	Not evaluated
F9m	Not evaluated	Not evaluated
F10m	Not evaluated	Not evaluated
F11m	3.50	3.50
F12m	1.00	2.50
F13m	5.09	4.70
<b>ARTIFICIALITY</b>		
A1m	4.50	4.50
A2m	2.23	2.23
A3m	0	0
A4m	0	0
A5m	2.00	2.00

Indicator	Before restoration	After restoration
A6m	21.00	1.67
A7m	3.87	0
A8m	0	0
A9m	0	3.00
A10m	0	0
A11m	0	0
A12m	6.50	6.50
<b>SCORE</b>		
MQIm	0.66	0.82

## 1.7 Narew River (Poland)

### 1.7.1. Study area

The Narew River is one of the main tributaries of the Wisla River, being 484 km in length. The headwaters of the Narew River are located in western Belarus and the catchment, which is mainly covered by Quaternary glacial deposits and has an extension of about 75000 km<sup>2</sup>, drains the north-eastern Polish Lowland. The hydrological regime is highly dominated by snow melt, and high flows usually occur in spring (March and April). The catchment can be delineated into 2 landscape units primarily based on land use type, since it is geologically homogeneous and no significant difference in elevation is present (Figure 1.16). The first landscape unit, which is located in the south-eastern portion of the catchment, encompasses an area dominated by forests, while the second unit is mainly occupied by agricultural areas (i.e. arable lands and pastures).

Segmentation of the Narew River was carried out in Deliverable 2.1 (Part 3) and the presented applications of MQI and MQIm are based on that delineation which identifies 7 segments (Figure 1.16).

An anabranching segment is present between Suraż and Rzędziany in the upper catchment (S6 in Figure 1.16). The two study reaches are located in the downstream portion of this segment (Figure 1.17), that is characterised by an extremely low channel slope (i.e. 0.06%) and sandy substrate. Catchment size at the downstream limit of the study reaches is about 3680 km<sup>2</sup>.

**Table 1.15 Narew River: main characteristics of the study reaches.**

Reach	Length (m)	Channel width (m)	Morphology	Confinement	Q <sub>mean</sub> (m <sup>3</sup> /s)	Q <sub>2</sub> (m <sup>3</sup> /s)
Degraded	4280	32	Sinuuous	U	16.9	36.3
Restored	5421	59	Anabranching	U	16.9	36.3

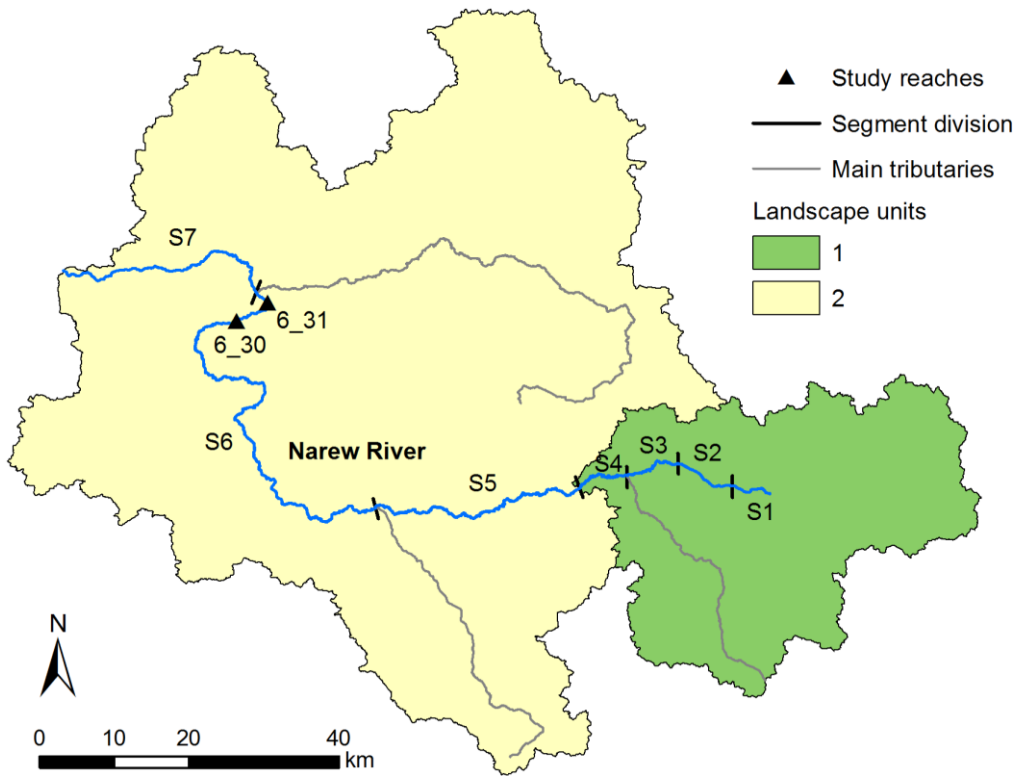

**Figure 1.16 Upper Narew catchment: delineation of landscape units and segments (codes from S1 to S7). Landscape units: (1) forested areas, (2) agricultural and urban areas.**

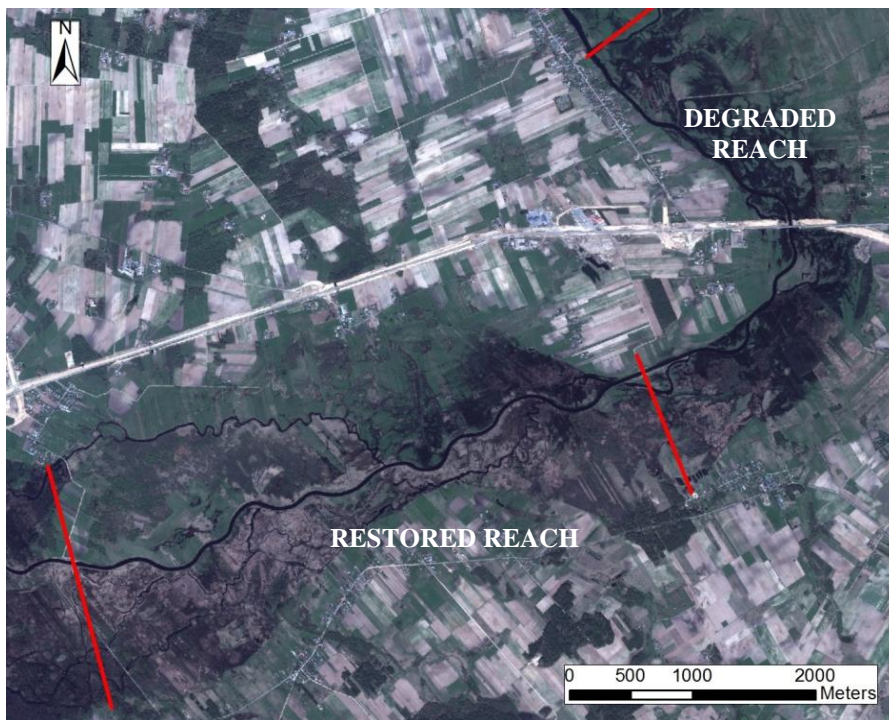

**Figure 1.17 Satellite image of the Narew River, including both the degraded and the restored reach.**



**Figure 1.18 Narew River, view of the degraded reach (A) and restored reach (B).**

The upstream study reach (segmentation code 6\_30) presents an anabranching morphology, where a main channel can be identified, due to its larger width and its regulated planform, while secondary channels present more natural features (Figure 1.18 and Table 1.15). The main channel underwent a series of interventions of straightening and rectification in the 1970s, which also concentrated the majority of the flow into this channel, leading to lowered water levels in the secondary channels. Islands and floodplain areas are mainly covered by herbaceous peat-forming vegetation and grasslands, while arboreal vegetation is generally scarce. Aquatic macrophytes are abundant in the secondary channels while their presence is rare along the main channel (Figure 10). The upstream limit of this study reach is defined by the presence of an artificial structure (i.e. a weir), that causes a longitudinal discontinuity along the main channel, while the downstream limit consists of a change of channel morphology (i.e. from anabranching to sinuous) and of the presence of another weir. Restoration activities were carried out in this reach since 1995 and they consisted of removing of excess sediment and vegetation to reconnect secondary side channels. In addition two submerged sills were constructed a few hundred meters upstream from the reach in order to raise water levels in the reactivated secondary channels (Figure 1.19).



**Figure 1.19 Upstream study reach: one of the submerged sills that is present a few hundred meters upstream of the restored reach (A) and a secondary channel with abundant aquatic vegetation (B).**

The adjacent downstream reach (segmentation code 6\_31) is the other case study. Its downstream limit corresponds to the confluence with the Supraśl River. The morphology

of the reach was anabranching until the 1970s, when severe interventions of straightening and rectification were carried out and established the present sinuous morphology (Figure 1.18 and Table 1.15). Remnants of abandoned channels and oxbow lakes are present in the adjacent floodplain that is mainly covered by grasslands, with a scarce presence of arboreal vegetation (Figure 1.20).

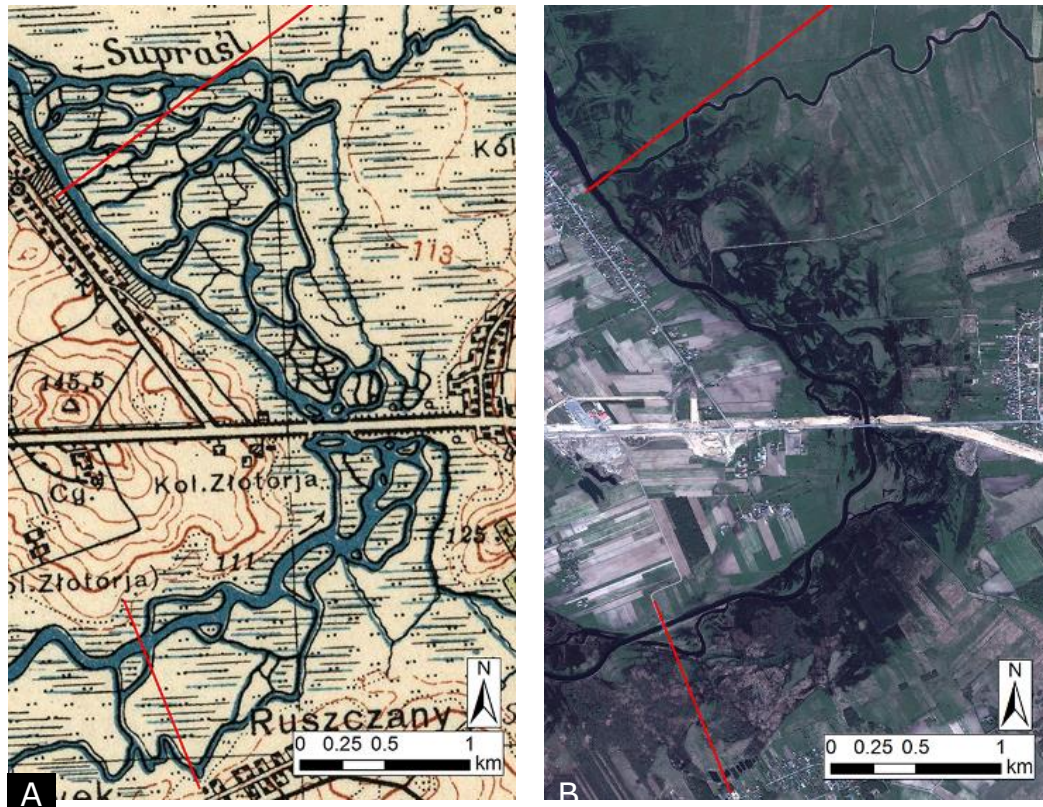

**Figure 1.20** Downstream study reach: the weir located at the upstream limit of the degraded reach (A) and a disconnected secondary channel with abundant aquatic vegetation (B).

ArcGIS basemap images (obtained in April 2011) were used to define the limits of the study reaches, to measure channel width and to conduct the remote-sensing analysis that is required to evaluate a set of MQI indicators. Historical maps from 1933 on a 1:100000 scale were used to evaluate adjustments in channel pattern and width (i.e. indicators CA1 and CA2) since historical aerial photographs of that period were not available. The presence of artificial structures in the study reaches (i.e. bank protections, levees) was checked for on topographic maps (scale 1:10000) and then verified during the field surveys that were carried out in July 2014.

### 1.7.2. Results

The downstream degraded reach (segmentation code 6\_31) presents a moderate morphological condition (i.e. MQI value = 0.64) (Table 1.16). The main impacts are related to the significant artificial changes of the river course (A8 indicator) which were carried out during the 1970s and which caused a change of the channel pattern from anabranching to sinuous (CA1 indicator) and a related intense narrowing of the channel width (CA2 indicator) (Figure 1.21). There is a limited presence of functional vegetation along the banks, of aquatic emergent macrophytes (F13 indicator), and a complete absence of dead wood (F11 indicator). Additionally, channel forming discharges (A1 indicator) and sediment transport (A2 indicator) are altered by the presence of the Siemianówka dam in the upstream catchment, near Bondary. In addition, sediment flux is impacted by the weir located at the upstream limit of the reach (Figure 1.20).



**Figure 1.21 Adjustments in channel pattern in the downstream study reach: anabranching morphology in the 1930s (topographic map - A) and actual sinuous morphology (satellite image - B).**

**Table 1.16 Narew River: summary of the MQI indicators for the degraded and restored reach before (BR) and after the restoration (AR).**

Indicator	Degraded	Restored (BR)	Restored (AR)
<b>FUNCTIONALITY</b>			
F1	B	B	B
F2	A	A	A
F4	Not evaluated	Not evaluated	Not evaluated
F5	A	A	A
F7	B	B	B
F8	B	A	A
F9	Not evaluated	Not evaluated	Not evaluated
F10	Not evaluated	Not evaluated	Not evaluated
F11	C	C	C
F12	B	A	A
F13	C	B	B
<b>ARTIFICIALITY</b>			
A1	C	C	C
A2	B1	B1	B1
A3	A	A	A
A4	A	B	B
A5	B	B	B

Indicator	Degraded	Restored (BR)	Restored (AR)
A6	A	A	A
A7	A	A	A
A8	C	A	A
A9	A	A	A
A10	A	A	A
A11	A	A	A
A12	C	C	C
CHANNEL ADJUSTMENTS			
CA1	B	A	A
CA2	C	C	C
CA3	A	A	A
SCORE AND CLASS			
<b>MQI</b>	0.64	0.70	0.70
<b>CLASS</b>	MODERATE	GOOD	GOOD

The morphological condition of the upstream anabranching reach (segmentation code 6\_30) before the interventions of restoration was good (i.e. MQI value = 0.70). The interventions of straightening and rectification of the 1970s were carried out only on the main channel within this reach (A8 indicator in class A) and therefore it maintained its anabranching morphology (CA1 indicator in class A), characterised by the presence of secondary channels and typical landforms such as oxbow lakes and abandoned channels in the floodplain (F8 indicator in class A) (Figure 1.19). The interventions of restoration did not lead to any improvement of the MQI value. Also the application of the MQIm index does not underline any significant change of morphological quality before and after the interventions of restoration (Table 1.17). The evaluation of all the indicators remained the same, with the exception of the negligible modifications of F12m, A5m, A6m and A7m indicators (Table 1.17).

**Table 1.17 Narew River: summary of the MQIm indicators for the degraded and restored reach before and after the restoration.**

Indicator	Before restoration	After restoration
FUNCTIONALITY		
F1m	4.00	4.00
F2m	0	0
F4m	Not evaluated	Not evaluated
F5m	0.16	0.16
F7m	2.57	2.57
F8m	0	0
F9m	Not evaluated	Not evaluated
F10m	Not evaluated	Not evaluated
F11m	3.50	3.50
F12m	0.51	0.55
F13m	3.70	3.70
ARTIFICIALITY		
A1m	7.50	7.50
A2m	6.97	6.97
A3m	0	0



Indicator	Before restoration	After restoration
A4m	4.00	4.00
A5m	2.11	2.34
A6m	0.32	0.25
A7m	0.13	0.11
A8m	0	0
A9m	0	0
A10m	0	0
A11m	0	0
A12m	6.50	6.50
<b>SCORE</b>		
MQIm	0.76	0.76

The lack of a remarkable improvement of the morphological conditions of the restored reach depends on the original objectives of the restoration interventions. They were planned with specific ecological purposes, i.e. to maintain and restore semiaquatic habitats such as peat-bogs and periodically inundated grasslands, which were endangered by the low water level in the secondary channels, and not for a sound morphological rehabilitation of the reach. The main morphological effect of restoration is the increase of the value of the anabranching index, from 2.40 to 2.96, due to the reconnection and reopening of secondary side channels (Figure 1.22).

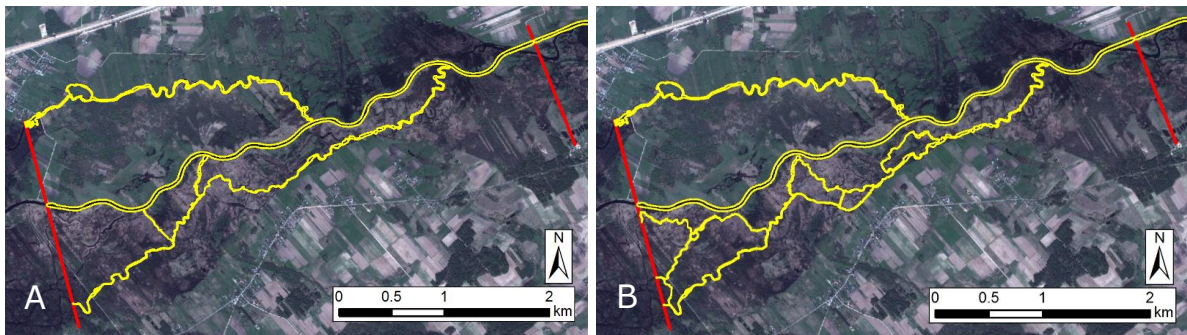

**Figure 1.22 Upstream study reach: active channels before (A) and after restoration (B).**

## **1.8 Thur River (Switzerland)**

### **1.8.1. Study area**

The Thur is a tributary of the Rhine river, with a length of 127 km, flowing from the Swiss Alps in the north east of Switzerland. The Thur catchment is 1730 km<sup>2</sup> and is a mainly limestone dominated alpine headwater, whereas the pre-alpine lowlands are dominated by 'Molasse'-Sandstones and Pleistocene unconsolidated sediments.

The discharge regime of the Thur is similar to unregulated alpine rivers due to the absence of natural or artificial reservoirs along its course. Thus, the water level can increase rapidly during rain events or snowmelt.

In the late 19th century, in order to protect residential areas from floods, the Thur river was embanked and its natural floodplain was drastically reduced. To date, efforts are being made aimed at increasing the natural protection against floods, and, at the same time promoting natural processes and habitat diversity.

In 2002 a restoration project was initiated near the villages of Niederneunforn and Altikon. At this point the upper catchment measures about 1605 km<sup>2</sup>. The mean discharge near the site is 52.9 m<sup>3</sup>/s. The length of the restoration is about 1.55 km. Here the river was widened and embankments along the right side of the river were removed to provide a larger space for the river. Additional wooden structures were added to enhance the ability of the river to meander.

According to the procedure summarized in Section 1.3, the Thur river was delineated and 5 segments were defined based on the geological map and the presence of major tributaries. Confinement, channel morphology and other longitudinal discontinuities were used to define reaches.

Two contiguous reaches were selected for the application of the MQI and MQIm: a degraded and a restored one (Figure 1.23). The catchment area at the restored reach is 1243 km<sup>2</sup>.



**Figure 1.23** Aerial photo of the Thur River, including both the degraded and restored reaches (Google earth, 2012).

Both reaches fall within a hilly physiographic unit and are unconfined. The degraded reach has a length of about 5654 m, an average channel width of 51 m and presents a straight morphology, having a channel sinuosity of 1.002 (Table 1.18). The degraded reach is characterised by the presence of lateral bars. The beginning of their presence defines the upstream limit of the reach. A view of the degraded reach is reported in Figure 1.24A.

The restored reach has a length of about 1777 m and an average channel width of 87 m. Its sinuosity is higher than 1.05 and the channel morphology is wandering (Table 1.18). The change of channel morphology marks the upstream limit of the restored reach. A view of the degraded reach is reported in Figure 1.24B.

**Table 1.18** Thur River: main characteristics of the study reaches.

Reach	Length (m)	Channel width (m)	Morphology	Confinement	Qmean (m <sup>3</sup> /s)	Q1.5 (m <sup>3</sup> /s)
Degraded	5654.5	51.2	Straight	Unconfined	52.9	N.A.
Restored	1773.6	87.4	Wandering	unconfined	52.9	N.A.

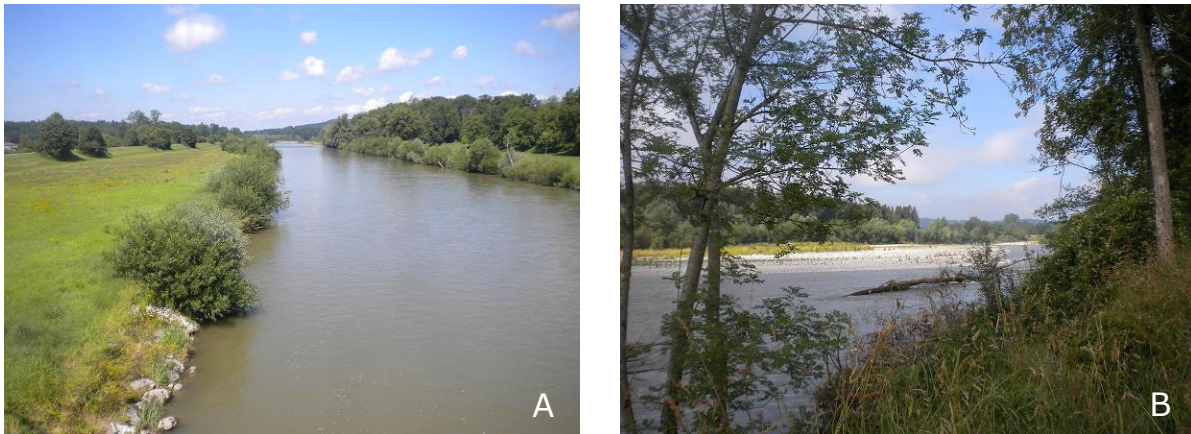

**Figure 1.24 Degraded (A) and restored (B) reach along the Thur river.**

Aerial photos of 2012 together with historical maps of 1935 were used to measure the channel width, its variations and the sinuosity as well as to conduct the remote-sensing analysis that is required to evaluate a set of MQI and MQIm indicators. The indicators measured by remote-sensing were later verified during the field surveys carried out in July 2014.

**1.8.2. Results**

The downstream degraded reach presents a moderate morphological condition (i.e. MQI value = 0.64) (Table 1.19). This is mainly related to the negligible presence of riverbank processes (F4), the limited presence of potentially erodible corridor (F5) linked to the presence of artificial levees (A7) and the consistent alteration of the morphological pattern (F7) especially due to the continuous presence of bank protections (A6) built together with levees in the late 19th century to protect residential areas from floods.

Similarly to the degraded reach, the morphological quality of the upstream reach before the interventions of restoration was moderate (MQI value = 0.65). Compared to the degraded reach, the functional vegetation is wider (about 110 m compared to 20 m), whereas its linear extension is lower (88% against 94%).

The interventions of restoration caused an improvement in morphological quality, and the class of morphological conditions improved to good (MQI value=0.8).

The improvement is related to the removal of bank protections (A6) which promoted the reactivation of bank processes (F4) and the development of morphological units (F7).

Also, the application of the MQIm underlines a significant change of the conditions before and after the interventions of restoration with an increase of 0.14 points (Table 1.20). The most significant improvement can be observed in indicators related to the presence of bank protections (A6m), but also in the indicators of processes of bank retreat, the presence of potentially erodible corridor, the variability of the cross section and width of functional vegetation (F4m, F5m, F9m and F12m).

**Table 1.19 Thur River: summary of the MQI indicators for the degraded and restored reach before (BR) and after the restoration (AR).**

Indicator	Degraded	Restored (BR)	Restored (AR)
<b>FUNCTIONALITY</b>			
F1	A	A	A
F2	A	A	A

Indicator	Degraded	Restored (BR)	Restored (AR)
F4	C	C	A
F5	C	C	A
F7	C	C	B
F8	Not evaluated	Not evaluated	Not evaluated
F9	C	C	B
F10	Not evaluated	Not evaluated	Not evaluated
F11	A	A	A
F12	C	A	A
F13	A	B	B
<b>ARTIFICIALITY</b>			
A1	A	A	A
A2	A	A	A
A3	A	A	A
A4	A	A	A
A5	B	A	A
A6	C+penalty	C+penalty	C
A7	B	B	B
A8	A	A	A
A9	A	A	A
A10	A	A	A
A11	A	A	A
A12	B	B	B
<b>CHANNEL ADJUSTMENTS</b>			
CA1	A	A	NO
CA2	A	A	NO
CA3	B	B	B
<b>SCORE AND CLASS</b>			
<b>MQI</b>	0.64	0.65	0.80
<b>CLASS</b>	MODERATE	MODERATE	GOOD

**Table 1.20 Thur River: summary of the MQIm indicators for the restored reach before and after the restoration.**

Indicator	Before restoration	After restoration
<b>FUNCTIONALITY</b>		
F1m	0	0
F2m	1.79	1.77
F4m	3.5	0
F5m	3.5	1.77
F7m	6	2.35
F8m	Not evaluated	Not evaluated
F9m	6	2.35
F10m	Not evaluated	Not evaluated

Indicator	Before restoration	After restoration
F11m	0	0
F12m	1.18	0.97
F13m	1.59	1.59
<b>ARTIFICIALITY</b>		
A1m	0	0
A2m	0	0
A3m	0	0
A4m	0	0
A5m	0	0
A6m	21	7.94
A7m	2.88	2.88
A8m	0	0
A9m	0	0
A10m	0	0
A11m	0	0
A12m	0	0
<b>SCORE</b>		
IQMm	0.74	0.88

## 1.9 Töss River (Switzerland)

### 1.9.1. Study area

The Töss is a 56 km long river flowing in the north east of Switzerland, originating in the north east of the Swiss Alps. As well as the Thur river, the Töss is a tributary of the Rhine river. It is a pre-alpine river, without natural or artificial reservoirs along its course. The natural morphological conditions have been highly modified due to the presence of numerous artificial weirs and embankments constructed in the early 20th century for flood protection purposes and to provide more land for agriculture.

In 1999 the Töss was restored for a total length of 200 metres. The river was widened on both sides of the main river channel. Along the course of the river, embankments were removed to provide more space for the river. Additionally, wooden structures were added to promote the development of morphological features and to increase the diversity of instream habitats and the corresponding biota.

The Töss was delimited according to the procedure summarised in Section 1.3. Confinement, channel morphology and other longitudinal discontinuities were used to define the reaches. Given the short extent of the restoration (about 200 m) which induced only local widening processes, it was not possible to identify 2 different reaches representing a restored and a degraded condition, as was the case in the other case studies. Thus, the MQI and the MQIm were applied only at one reach which includes the restoration site (Figure 1.25 and Figure 1.26), and an adjacent reach with comparable characteristics (in terms of confinement, degree of artificiality, etc.) was not available. This selected reach is 4746 m long. The upstream limit of the reach is represented by an out-take and the downstream limit is defined by the presence of a tributary. The reach is partly confined and presents straight channel morphology, having a sinuosity index of 1.03. Its average channel width is about 21 m (Table 1.21). The portion of the reach which was not restored is characterised by the presence of numerous sills (Figure 1.26A).

Aerial photos from 2012 provided by Google Earth together with historical maps from 1935 were used to measure the channel width, its variations and sinuosity as well as to conduct the remote-sensing analysis that is required to evaluate a set of MQI and MQIm indicators. The indicators measured by remote-sensing were later verified during the field surveys carried out in July 2014.



**Figure 1.25** Aerial photo of the Töss River at the selected reach (Google earth, 2012).

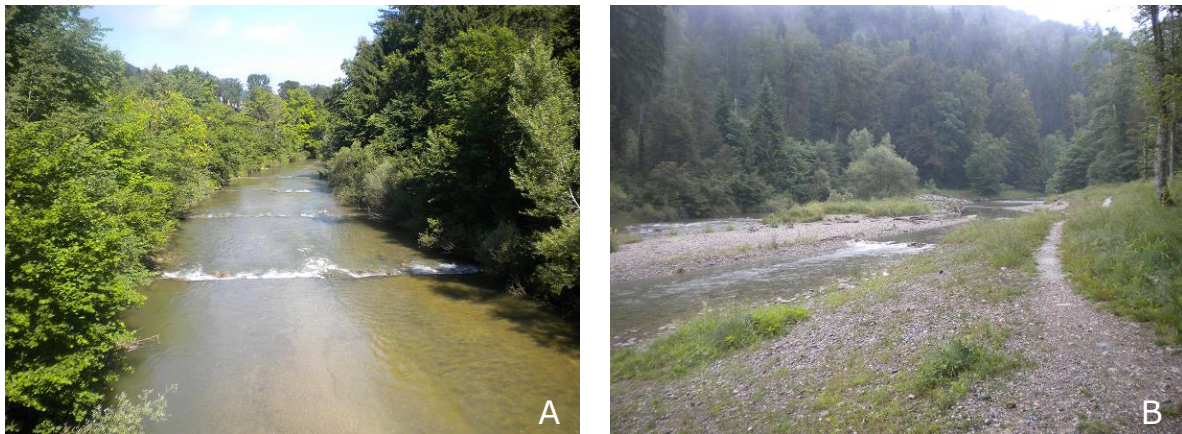

**Figure 1.26** Töss River, view of the not restored portion of the reach characterised by the numerous presence of sills and portion of the restored reach in A and B, respectively.

**Table 1.21** Töss River: main characteristics of the study reaches.

Reach	Length (m)	Channel width (m)	Morphology	Confinement	Q <sub>mean</sub> (m <sup>3</sup> /s)	Q <sub>1.5</sub> (m <sup>3</sup> /s)
	4746	20.5	Straight	Partially confined	9.9	N.A.

### 1.9.2. Results

The morphological quality of the reach before the interventions of restoration was moderate with the MQI value equal to 0.54 (Table 1.22). This is mainly related to the negligible presence of floodplain (F2) and potentially erodible corridor (F5) due to the continuous presence of bank protections. These latter, together with an important presence of bed stabilization structures (96 sills were counted along the reach), are also responsible for the absence of riverbank processes (F4) and variability of cross section (F9), and the occurrence of consistent alterations of the morphological patter (F7).

The interventions of restoration caused only a slight improvement of the MQI whose value increased from 0.54 to 0.56 while the class of morphological conditions did not change. The improvement is only related to a slight widening of the floodplain, which increased from about 7 m to 12 m. Although bank protections were removed and the channel was widened, the short extent of these interventions did not allow the MQI indicators to change the class and therefore to capture any improvement in the functionality of the reach. The removal of bank protections and the resulting improvement of the morphological quality of the reach in terms of enhanced variability of cross section and decrease of morphological alteration can be observed only in the corresponding MQIm indicators (i.e. A6m, F7m and F9m, respectively in Table 1.23).

However, the application of the MQIm also does not highlight any significant change of the conditions before and after the interventions of restoration and the final scores only differ by 0.01.

**Table 1.22 Töss River: summary of the MQI indicators for the reach before and after the restoration.**

Indicator	Before restoration	After restoration
<b>FUNCTIONALITY</b>		
F1	A	A
F2	C	B2
F4	C	C
F5	C	C
F7	C	C
F8	Not evaluated	Not evaluated
F9	C	C
F10	A	A
F11	C	C
F12	A	A
F13	A	A
<b>ARTIFICIALITY</b>		
A1	A	A
A2	A	A
A3	A	A
A4	A	A
A5	B	B
A6	C+penalty	C+penalty
A7	A	A
A8	A	A
A9	C1	C1
A10	A	A

Indicator	Before restoration	After restoration
A11	B	B
A12	B	B
<b>CHANNEL ADJUSTMENTS</b>		
CA1	Not evaluated	Not evaluated
CA2	Not evaluated	Not evaluated
CA3	B	B
<b>SCORE AND CLASS</b>		
<b>IQM</b>	0.54	0.56
<b>CLASS</b>	MODERATE	MODERATE

**Table 1.23 Töss River: summary of the MQIm indicators for the reach before and after the restoration.**

Indicator	Before restoration	After restoration
<b>FUNCTIONALITY</b>		
F1m	0	0
F2m	4.4	3.81
F4m	3.5	3.5
F5m	3.5	3.45
F7m	6	5.88
F8m	Not evaluated	Not evaluated
F9m	6	5.88
F10m	0	0
F11m	3.5	3.5
F12m	0.43	0.44
F13m	0	0
<b>ARTIFICIALITY</b>		
A1m	0	0
A2m	0	0
A3m	0	0
A4m	15.06	15.06
A5m	2.27	2.27
A6m	21	19.8
A7m	0	0
A8m	0	0
A9m	0	0
A10m	0	0
A11m	3.5	3.5
A12m	3.5	3.5
<b>SCORE</b>		
IQMm	0.62	0.63



## 1.10 Vaarajoki River (Finland)

### 1.10.1. Study area

The Vääräjoki river catchment is located in the central-western part of Finland, in the Kalajoki river catchment (Figure 1.27). It is 835 km<sup>2</sup> at the downstream reach outlet and is located in a low-relief area, where the ancient reliefs have been modelled by glacier erosion during the Quaternary glaciations. The geology is thus dominated by old rocks unearthed by the action of glaciers: metamorphic (i.e. mica schists and mica gneiss) and intrusive crystalline (i.e. granite and granodiorite) rocks. Moraines and other finer lacustrine-glacial sediments dominate the superficial deposits. The hydrographical system is fluvio-glacial and fluvio-lacustrine where rivers and lakes mainly occupy the groove dug by glaciers. Like in the rest of Finland, there is a low evapotranspiration and low soil permeability (i.e. 10% of the Finnish surface is occupied by lakes). The hydrological regime is highly dominated by snow and glacier melt (high flows in spring) and rain (high flows in autumn).

The Vääräjoki river is about 107 km in length, and has mainly a sinuous unconfined channel, with low slopes (i.e. 0.1% along the segment where studied reaches are located). The dominant channel sediments are boulders and cobbles, whereas in the surrounding plain area fine sediments dominate (i.e. peat, clay and silt). For this reason, differently from other low gradient streams, the channel bed shows a relative heterogeneity of sediment and geomorphic units (i.e. presence of areas of relatively turbulent flow, bars and islands with heterogeneous sediment).

The river and its catchment have been influenced by human impacts over time, where the most important has been the removal of a huge amount of coarse sediment (about 200,000 m<sup>3</sup>) in order to allow transport of wood for the timber activity, before the 1950s (mainly in the decade 1920-1930) (Figure 1.28). During the 1950s (1955-1959) additional sediment was been removed for flood protection, together with river channelization (about 320,000 m<sup>3</sup>). This caused a reduction of instream habitats and an overall river channel homogenisation (i.e. loss of areas with rapids). At the beginning of the 20th century two lakes located along the main course of the Vääräjoki were drained, in order to provide lands for agriculture. Several secondary channels were also activated for the implementation of watermills. Since the 1990s a widespread programme for river restoration involved the most Finnish rivers, including the Vääräjoki. Here the restoration occurred between 1997 and 2006 and mainly concerned the improvement of instream habitats for fish for about 16 km of the river's length.

The Vääräjoki river was divided into segments and reaches according to the procedure summarised in Section 1.3. Topographic maps having a resolution of about 2.5 m property of the NLS (Natural Land Survey of Finland; <http://kansalaisen.karttapaikka.fi>), geological and land use maps (Corine Land Cover 2006 of level 1), images from Google Earth, and GIS layers including the catchment area and the stream network, were used for this purpose.

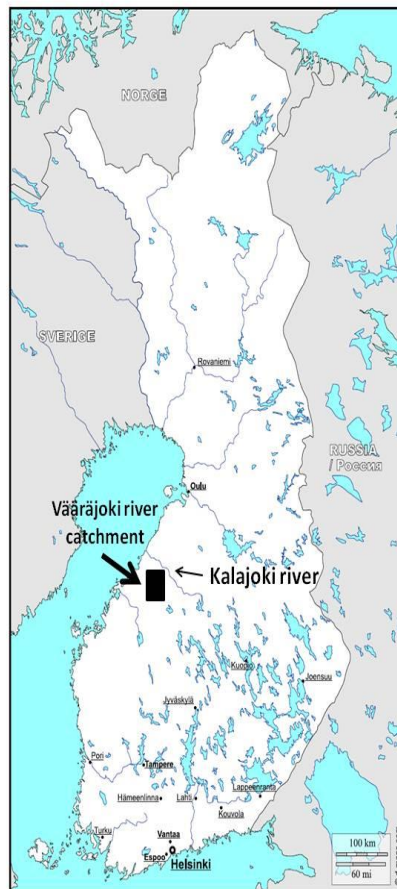

**Figure 1.27** Location of the Vääräjoki river catchment.



**Figure 1.28** Dredging along the Vääräjoki river during the 1920s.

The relief of the catchment does not vary significantly (from 150 until 60 m a.s.l.); thus, landscape units were delineated on the basis of geology and land use at the catchment

scale. First, 4 macro-areas for 3 homogeneous bedrock geology classes were identified: intrusive crystalline rocks (granite and granodiorite) versus metamorphic rocks (mica schist and mica gneiss), plus an intermediate class. Then, these areas with 2 classes of land use (forest and semi-natural areas; agriculture and urban areas) were combined, and 5 landscape units were identified (Figure 1.29). The combination of the landscape units and the river course and the location of confluences with main tributaries (i.e. having a catchment area at least 2/3 of the main river catchment area) provided the delineation of 8 segments.

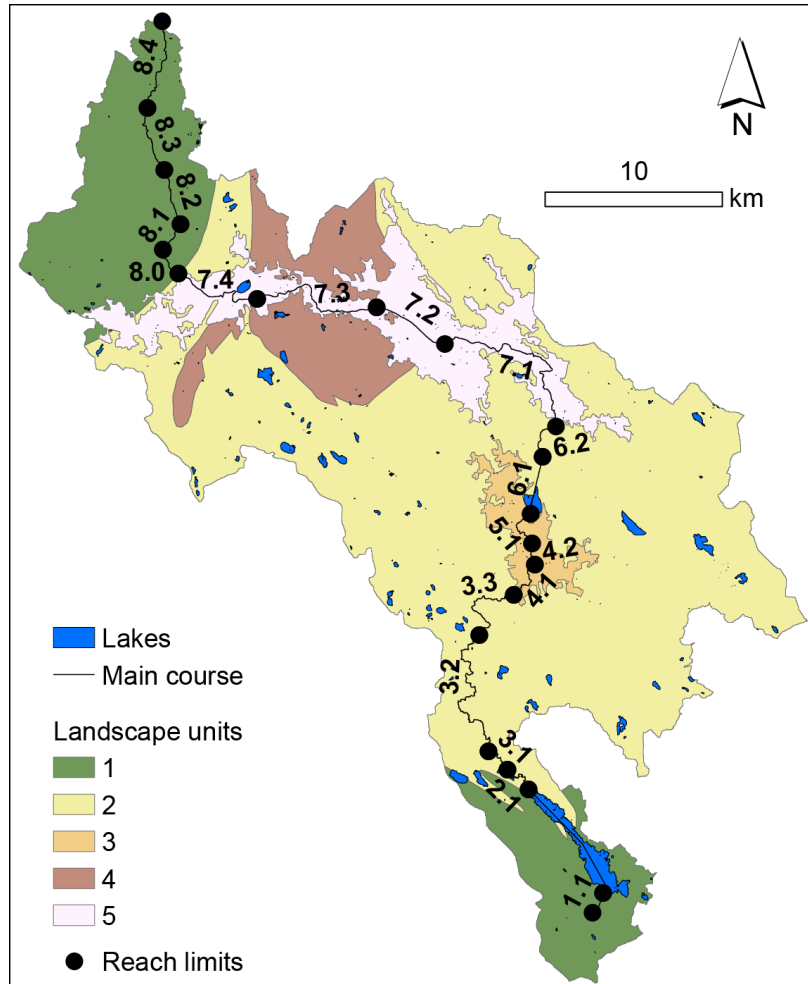

**Figure 1.29 Vääräjoki River: the delineation of landscape units and reaches. Landscape units: (1) Intrusive crystalline rocks, forested and semi-natural areas; (2) Metamorphic rocks, forested and semi-natural areas; (3) Metamorphic rocks, agriculture and urban areas; (4) Intermediate rocks, forested and semi-natural areas; (5) Intermediate rocks, agriculture and urban areas.**

The confinement index and degree were calculated considering that the only elements of confinement are represented by glacial deposits, such as hummocky moraines. The resulting values, together with the indexes of channel pattern morphology (i.e. sinuosity and anabranching index), the presence and the assemblage of morphological units, artificial elements (i.e. channelization) and tributaries, allowed for the delimitation of 19 reaches.

The two selected reaches are located along segment 8. Their main characters are reported in Table 1.24.

The two reaches selected for this study are located in the downstream portion of the Vääräjoki catchment, about 18 km from the confluence with the Kalajoki river, in an

agricultural area. Reaches are 1895.1 and 5857.7 m long, i.e. the upstream degraded and the downstream restored, respectively (Figure 1.30). The restoration in the restored reach area concerns about 1.4 km river length (mainly in the downstream portion of reach 8.4). Boulders removed for the timber activity have been reintroduced in the channel (mainly along the margins) in order to improve the bed heterogeneity and recreate habitats for fish (i.e. enable the breeding and migration of fish). Also some finer sediment (i.e. gravel) was introduced to provide nursery habitats for salmonids. Some of the artificial channels used for direct water through the watermills have also been restored (i.e. secondary channels).

In order to apply the second phase of calculation of the MQI and MQIm index, additional data were acquired:

- aerial photos: recent images (2010) of about 2 m of resolution; old images (1956 and 1947 for the degraded and restored reaches, respectively) of about 50 cm of resolution, property of the Finnish NLS (National Land Survey of Finland (<http://www.maanmittauslaitos.fi/en/kartat>));
- online information about superficial sediment and geology (<http://gtkdata.gtk.fi/maankamara/>);
- discharge data (between 2002 and 2012; modelled): the mean annual discharge and the 2-year flood discharge;
- information on the existing human pressures at the catchment scale (e.g. embankments and channelised segments; presence of structures which may alter the hydrology and sediment regimes;
- location of the restoration and information on the type of restoration.

The indicators measured by remote-sensing were later verified during the field surveys carried out in the period June 15th to 19th 2014.



**Figure 1.30** The two studied river reaches of the Vääräjoki river: (a) reach 8.1 degraded; (b) reach 8.4 restored

**Table 1.24 Vääräjoki River: main characteristics of the analysed reaches.**

Reach	Length (m)	Channel width (m)	Morphology	Confinement	Q <sub>mean</sub> (m <sup>3</sup> /s)	Q <sub>2</sub> (m <sup>3</sup> /s)
Degraded	1895.1	41.2	Sinuous	U	9.9	60.4
Restored	5857.7	26.8	Sinuous (with local anabranching)	U	9.9	60.4

**1.10.2. Results**

The results of the application of the MQI and MQIm index are reported in Table 1.25 and Table 1.26, respectively. Figure 1.31 and Figure 1.32 shows some representative pictures of reaches 8.1 (degraded) and 8.4 (restored), respectively. Note that the indicator F9 (i.e. Variability of the cross section) was applied. In fact, although this is a low energy river, the presence of heterogeneous sediment (i.e. inherited by glacial activity) determines a certain variability of the cross section.



**Figure 1.31- Vääräjoki River: pictures of the reach 8.1 degraded (upstream), from upstream to downstream.**

The score of the MQI is quite similar between reaches and even before and after the restoration for the restored reach 8.4 (Table 1.25). Both reaches show a good morphological quality. Even if the functionality of the reaches shows some critical points, especially in the degraded reach and the restored one before the restoration (i.e. the variability of the cross section and related geomorphic units), there is a scarce presence of artificial elements, especially at the catchment scale (without considering land use). The widespread and significant removal of sediment before the 1950s did not cause severe channel adjustments.

The score of the MQIm index also does not vary significantly between before and after the restoration for reach 8.4 (Table 1.26). Again, the main differences before and after the restoration interventions are determined by the improvement of the instream habitats that enhanced the cross sections and geomorphic units variability.



**Figure 1.32 Vääräjoki River: pictures of the reach 8.4 restored (downstream), from upstream to downstream.**

**Table 1.25 Vääräjoki River: summary of the IQM indicators for the degraded and restored reach before (BR) and after the restoration (AR).**

Indicator	Degraded	Restored (BR)	Restored (AR)
<b>FUNCTIONALITY</b>			
F1	A	A	A
F2	B1	B1	B1
F4	Not evaluated	Not evaluated	Not evaluated
F5	A	A	A
F7	C	C	B
F8	Not evaluated	Not evaluated	Not evaluated
F9	C	C	B
F10	A	A	A
F11	A	A	A
F12	B	A	A

Indicator	Degraded	Restored (BR)	Restored (AR)
F13	A	A	A
<b>ARTIFICIALITY</b>			
A1	A	A	A
A2	A	A	A
A3	A	A	A
A4	A	A	A
A5	B	B	B
A6	B	A	A
A7	A	A	A
A8	A	A	A
A9	Not evaluated	Not evaluated	Not evaluated
A10	B1	B1	B1
A11	A	A	A
A12	B	B	B
<b>CHANNEL ADJUSTMENTS</b>			
CA1	A	A	A
CA2	A	A	A
CA3	B	B	B
<b>SCORE AND CLASS</b>			
<b>IQM</b>	0.78	0.82	0.85
<b>CLASS</b>	GOOD	GOOD	HIGH

**Table 1.26 Vääräjoki River: summary of the IQMm indicators for the restored reach before and after the restoration.**

Indicator	Before restoration	After restoration
<b>FUNCTIONALITY</b>		
F1m	0	0
F2m	1.86	1.86
F4m	Not evaluated	Not evaluated
F5m	1.03	1.03
F7m	4.62	3.3
F8m	Not evaluated	Not evaluated
F9m	4.62	3.3
F10m	0	0
F11m	0	0
F12m	0.94	0.94
F13m	0.66	0.66
<b>ARTIFICIALITY</b>		
A1m	0	0
A2m	0	0
A3m	0	0
A4m	0	0
A5m	2	2

Indicator	Before restoration	After restoration
A6m	0.53	0.53
A7m	0	0
A8m	0	0
A9m	0	0
A10m	4.5	4.5
A11m	0	0
A12m	3.5	3.5
<b>SCORE</b>		
IQMm	0.87	0.89



## 1.11 Results

The first important goal of this study is represented by the improvement of the original version of the Morphological Quality Index (MQI) and Morphological Quality Index for monitoring (MQIm) developed in Italy (Rinaldi et al., 2013). In fact, the application of the indices to the European case studies allowed the testing of the original versions and adapting them in order to better represent those alterations and channel morphologies which were under-represented in the Italian version.

The changes involved various aspects, including the score of some indicators and the inclusion of channel morphologies which were not accounted for in the original version. Significant changes were implemented to the indicators related to the functionality and artificiality of the vegetation (see D6.2 Part 3).

Looking at the results of the applications carried out with the new version of the MQI and MQIm, a summary of the overall outcomes is reported in Figure 1.33 and Table 1.27. Figure 1.33A shows that for each case study, the morphological conditions of the degraded reaches are worst compared with the quality of the restored reaches. In more detail, one case (Becva) falls into the class 'poor' (i.e.,  $0.3 \leq \text{MQI} < 0.5$ ); five cases (i.e. Aurino, Drau, Narew, Thur and Lippe) in the class 'moderate' (i.e.,  $0.5 \leq \text{MQI} < 0.7$ ); one case (Vääräjoki) in the class 'good' (i.e.,  $0.7 \leq \text{MQI} < 0.85$ ).

Similarly, the initial morphological quality (before restoration) of the restored reach is extremely variable (Figure 1.33B), ranging from poor (MQI=0.34, Becva) to good (MQI=0.82, Vääräjoki). In detail, one case (Becva) falls into the class 'poor', five cases (Aurino, Drau, Lippe, Thur, Töss) in the class 'moderate', two cases (Narew, Vääräjoki) in the class 'good'. No cases fell into bad (MQI<0.3) or high (MQI $\geq$ 0.85) initial conditions. It is clear that, in most cases, pre-restoration hydromorphological conditions were critical (poor or moderate classes) and restoration was actually aimed at enhancing some morphological processes and/or forms, but in two cases initial morphological quality was not a main issue and restoration measures were mainly addressed to enhance ecological conditions.

In general, as expected, in all the cases the hydromorphological measures undertaken by the restoration projects improved the morphological conditions. However, the enhancement of morphological quality was variable. In most cases the morphological conditions improved from a moderate to a good state (Drau, Thur, Lippe and Aurino). In other cases the MQI class did not vary (Töss and Narew). In the next section the reasons for this variability are discussed.

In Figure 1.33C, the difference of the index between the two assessments confirms the improvement of the morphological state of the reaches following the restoration interventions. Due to the different score system, based on continuous mathematical functions instead of classes, the variations of the MQIm before and after the restoration differ from the variations of the MQI (see also Table 1.27). However, it is important to note that the MQIm only provide a tendency of morphological conditions (enhancement or deterioration) which can be evaluate by the difference of two conditions, whereas the value of MQIm related to a single situation is not meaningful.

Cross checking results in Figure 1.33 and Table 1.27 we also observed that the morphological conditions of the degraded reaches are very similar to the morphological conditions before the restoration, although in most cases the pre-restoration conditions are slightly better than the conditions of the degraded reaches. Small differences could be due to some gaps of data of the pre-restoration conditions, given that this analysis has been carried out *a posteriori*, implying that some uncertainty exist on some of the indicators.

Table 1.27 also summarises indicators of functionality and artificiality which varied in the different assessments. As expected, changes involved not only those indicators strictly related to the intervention measures. For instance, in the case of the removal of bank protection and/or artificial levees, not only the indicators F4/F4m, A6/A6m and A7/A7m

varied, but also indicators related to the cross section variability and morphological units.

Specifically, in case of Becva, Lippe, Vaaraoki, Aurino, Drau and Thur, the most sensitive indicators to the restoration measures are those related to the bank processes, cross section variability and morphological units (F4, F7, F9 and A6). In two cases (Becva and Lippe) we also noted an increase of the floodplain, the potentially erodible corridor and the linear extension of the riparian vegetation.

In case of the Narew, the indicators which varied with the restoration are those related to the functionality of vegetation in terms of width, and those related to the removal of bank protections and artificial levees.

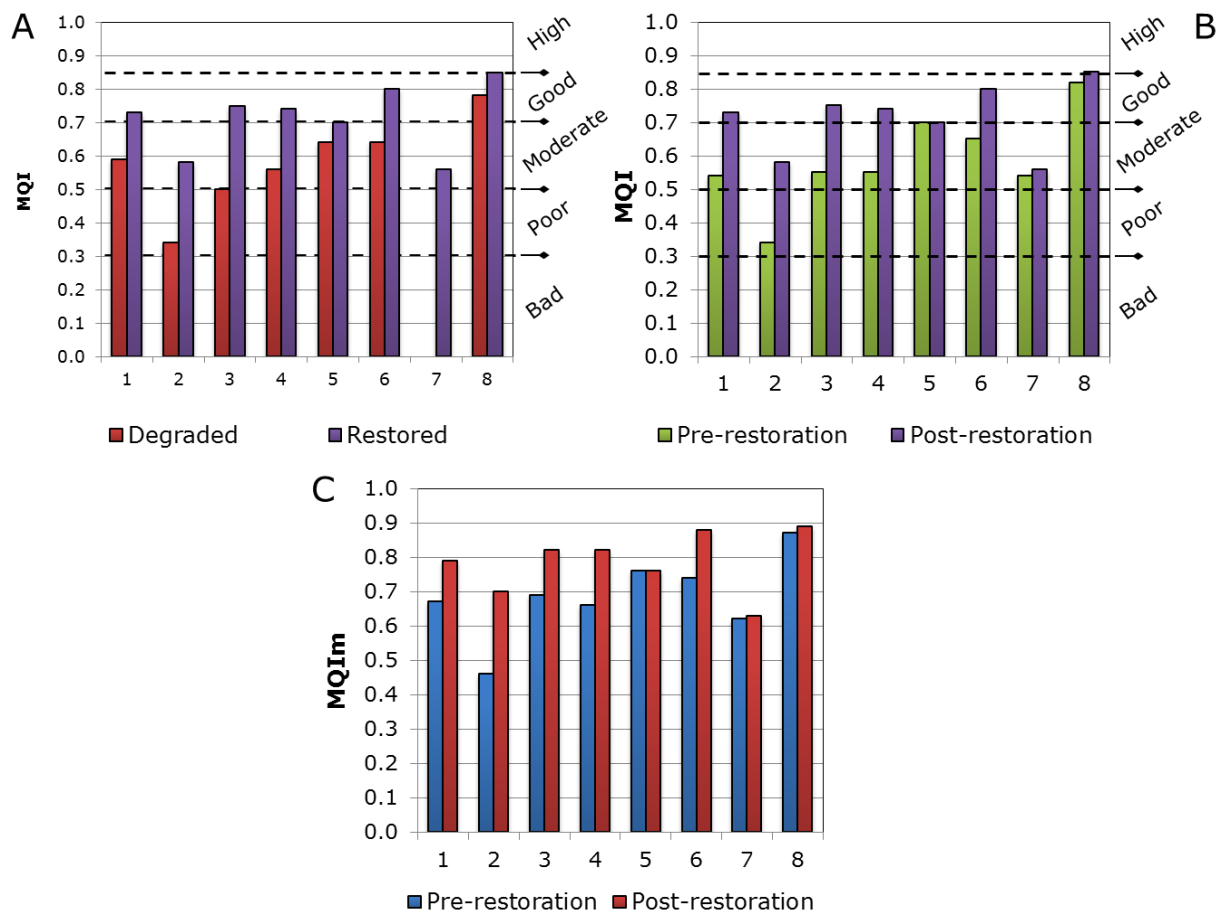

**Figure 1.33 Summary of results. A: MQI for degraded and restored conditions; B:MQI before restoration and after restoration; C: MQIm before and after restoration. 1: Aurino; 2: Becva; 3: Drau; 4: Lippe; 5: Narew; 6: Thur; 7: Töss ; 8 : Vääräjoki.**

**Table 1.27 Summary of the main characteristics of the reaches and the results of the applications of the MQI and MQIm indices.  $\Delta$ MQIm is the variation of the MQIm given by the difference between the MQIm after the restoration and the MQIm before restoration. The term 'Changes' refers to the MQIm indicators which varied at the restored reach before and after the restoration.**

River name	Drau	Thur	Becva	Vääräjoki	Lippe	Narew	Töss	Aurino
<b>Catchment (km<sup>2</sup>)</b>	2433	1605	1532	835	1896	3680	188	629
<b>Bed sediment</b>	G	G	G	B	S	S	G	G
<b>Confinement</b>	U	U	U	U	U	U	PC	PC
<b>Morphology</b>	W	W	S	S	S	A	St	M
<b>Qmean (m<sup>3</sup>/s)</b>	62.6	52.9	16.6	9.9	17.7	16.9	9.9	20
<b>Restoration Length (km)</b>	1.9	1.55	0.45	1.4	2.0	4.6	0.21	1.19
<b>MQI degraded</b>	MODERATE (0.50)	MODERATE (0.64)	POOR (0.34)	GOOD (0.78)	MODERATE (0.56)	MODERATE (0.64)	-	MODERATE (0.59)
<b>MQI Pre-restoration</b>	MODERATE (0.55)	MODERATE (0.65)	POOR (0.34)	GOOD (0.82)	MODERATE (0.55)	GOOD (0.70)	MODERATE (0.54)	MODERATE (0.54)
<b>MQI Post-restoration</b>	GOOD (0.75)	GOOD (0.80)	MODERATE (0.58)	HIGH (0.85)	GOOD (0.74)	GOOD (0.70)	MODERATE (0.56)	GOOD (0.73)
<b><math>\Delta</math>MQIm</b>	0.13	0.14	0.24	0.02	0.16	0.00	0.01	0.12
<b>Changes in Functionality</b>	F4m, F7m, F9m, F11m	F2m, F4m, F5m, F7m, F9m, F12m	F1m, F2m, F4m, F5m, F7m, F9m, F11m, F12m	F7m, F9m	F2m, F5m, F12m, F13m	F12m	F2m, F5m, F7m, Fm9, F12m	F4m, F7m, F10m, F11m, F12m, F13m
<b>Changes in Artificiality</b>	A6m	A6m	A6m, A10m, A11m	-	A6m, A7m, A9m	A5m, A6m, A7m	A6m	A5m, A6m, A9m, A10m
<b>Bed Sediment:</b> G=Gravel, S= Sand, B= boulder, blocks, cobbles; <b>Morphology:</b> St=Straight, S=Sinuous, M=Meandering, W=wandering, A=Anabranching; <b>Confinement:</b> U=unconfined, PC= Partially confined.								

## 1.12 Discussion

Although the number of case studies is relatively low to provide statistically robust correlations, the results of the applications have been analysed in order to identify the dominant factors responsible for the morphological response of the selected rivers to the restoration measures.

The increment of MQIm (expressed by  $\Delta\text{MQIm}$ ) is used as a measure of the morphological enhancement due to restoration, because the MQIm is more sensitive to the effects of the interventions.

The varying response of morphological quality related to the restoration measures may depend on a number of factors. We divided them into two broad groups: (1) initial morphological conditions; and (2) restoration interventions.

### (1) Initial morphological conditions

Different initial conditions have been taken into account. Figure 1.34 summarises the results of the analyses related to this aspect.

First of all, the channel morphology before the restoration has been considered, being strictly linked to the potential for morphological changes. In Figure 1.34A, channel morphologies represented by the case studies have been included according to the increasing order of sensitivity (D6.2 Part 1). We observed that the improvement of the MQIm in reaches with a low sensitivity (Narew and Töss, anabranching and straight, respectively) was very low. The improvement was higher in those reaches characterized by a channel morphology with a higher sensitivity (Aurino and Drau, meandering and wandering, respectively). For sinuous morphology the response of reaches to the restoration was variable.

The channel width before the restoration was also considered, but a greater data dispersion was found and the results do not show any trend (Figure 1.34B). For instance, in the case of narrow reaches (Töss and Lippe), the response to the restoration was very different, with the improvement of the MQIm varying from 0.01 and 0.16, respectively. This suggests that channel width does not have a significant influence on restoration response, probably because other factors are more relevant.

The initial morphological quality may have an important influence on the increment of quality that it is possible to achieve. This aspect is analysed in Figure 1.34C, where the initial morphological quality is expressed by the pre-restoration MQI. The trend line does not have a statistical significance but is used to visualise the overall trend. It is evident that the degree of improvement drastically decreases with increasing initial morphological quality, i.e., the benefit of the restoration is very low when the initial quality is already high. The Becva (2) is the river with the lowest initial MQI and the highest increase of morphological quality. The Töss (7) is clearly out of this trend, i.e. the increment of quality is extremely low although the initial MQI is relatively low. This is mainly related to the spatial scale of the intervention.

The results do not vary if we consider separately the variations in terms of functionality ( $\Delta\text{MQIFm}$ ) and artificiality ( $\Delta\text{MQIAM}$ ). This is shown in Figure 1.34D and Figure 1.34E where the  $\Delta\text{MQIFm}$  and  $\Delta\text{MQIAM}$  in the y-axis represent the per cent variation of the sub-indices of Functionality and Artificialities of the MQIm.

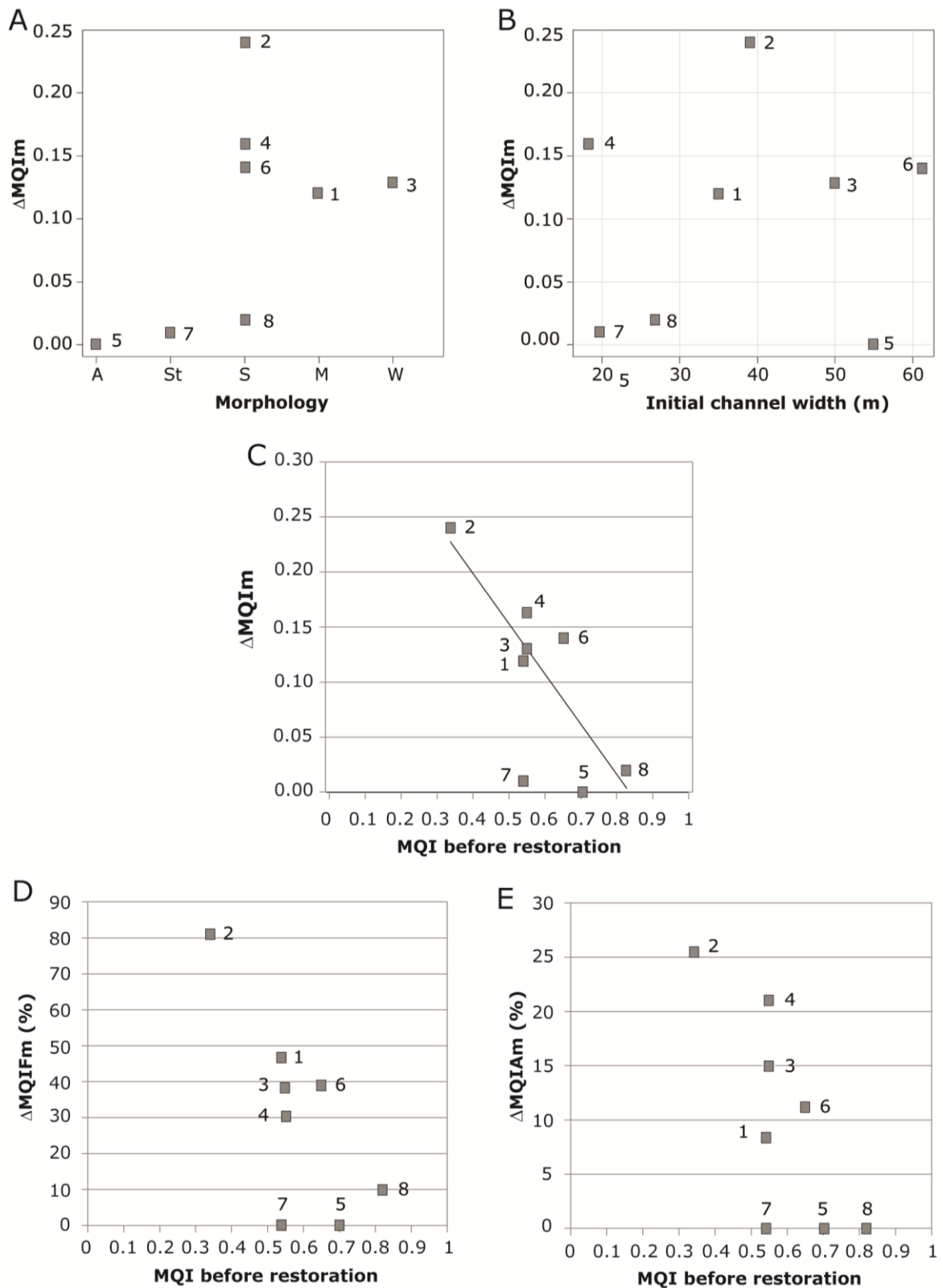
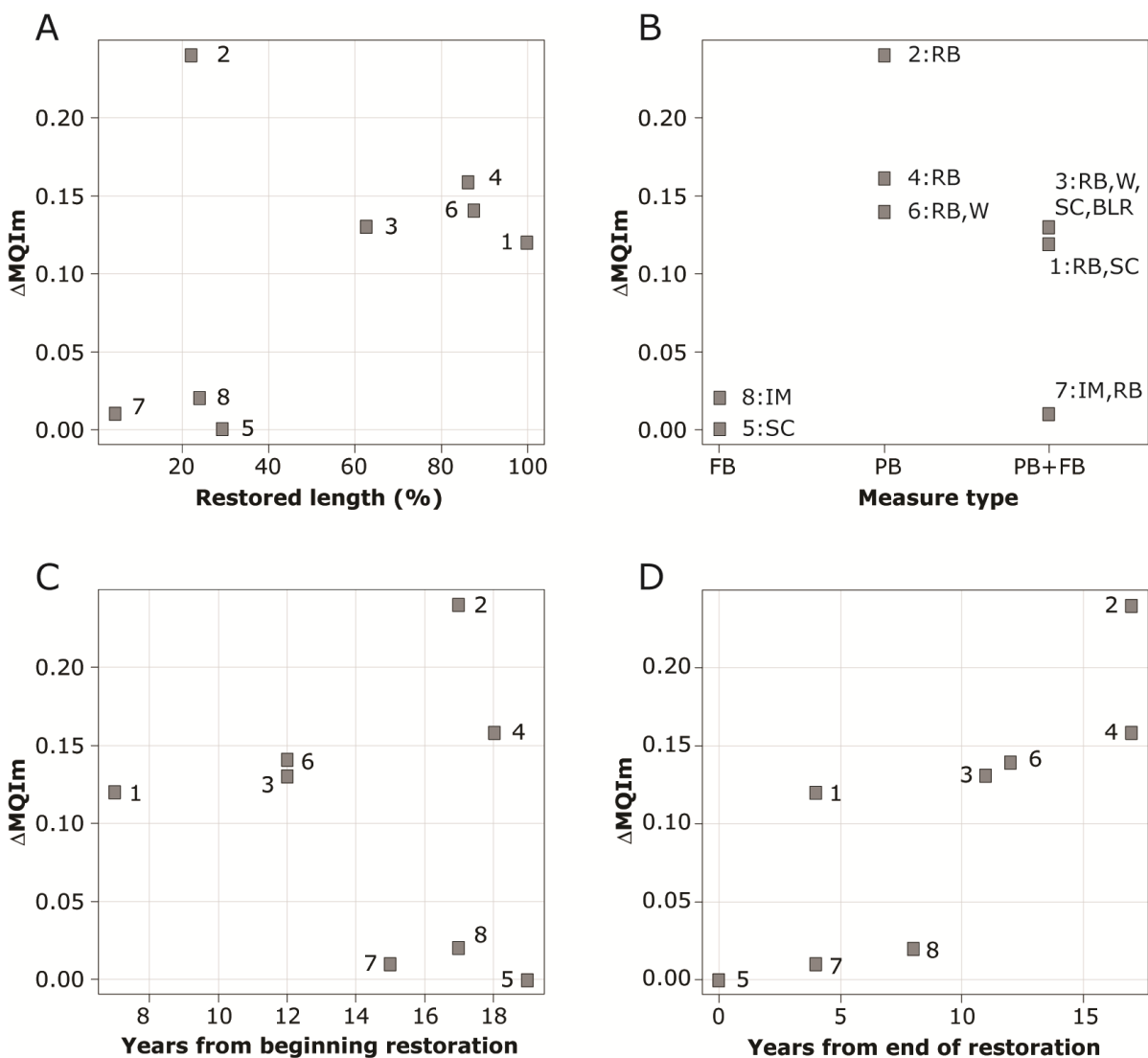

Figure 1.34 Increment of MQIm ( $\Delta MQIm$ ) vs. initial channel morphologies, channel width and morphological quality in A, B and C, respectively. Increment of functionality ( $\Delta MQIFm$ ) and artificiality ( $\Delta MQIAM$ ) vs. initial morphological quality in D and E, respectively. 1: Aurino; 2: Becva; 3: Drau; 4: Lippe; 5: Narew; 6: Thur; 7: Töss; 8: Vääräjoki.

(2) Restoration interventions

A second aspect considered in the analyses is the restoration intervention, in terms of spatial and temporal scale and type of measures.

Concerning the spatial scale, Figure 1.35A plots the increment of MQIm as a function of the restored length (%). As expected, the overall tendency (trend line) shows that the enhancement in morphological quality increases with the percentage of restored length. Along this trend line, the negligible increment of morphological quality for the Töss (7), the Vääräjoki (8), and the Narew (5) is clearly explained by the small percentage of the restored site when compared to the total reach length. Conversely, the Lippe (4), Thur (6), Drau (3) and Aurino (1) show a significant increase in morphological quality in relation to a high percentage of restored length. A notable exception from this trend line, which clearly appears as an outlier, is the Becva (2), which is characterised by the highest increment in morphological quality but with a low percentage of restored reach.



**Figure 1.35** Increment of MQIm ( $\Delta MQIm$ ) vs. the percentage of restored reach, the different type of interventions, and the years since the beginning and the end of the restoration in A, B, C, and D, respectively. FB= Form-based, PB= Process-based. 1: Aurino; 2: Becva; 3: Drau; 4: Lippe; 5: Narew; 6: Thur; 7: Töss; 8: Vääräjoki.

Regarding the temporal scale, the increment of MQIm as a function of the years between the beginning and the end of the interventions was examined in Figure 1.35C and Figure 1.35D, respectively. In some cases the years since the beginning and the end of the interventions coincide (i.e., the restoration interventions were completed in one year). This is the case with the Becva, where the restoration consisted in the 1997 flood of removing bank protections, and the Thur, where interventions were concluded in one year. Figure 1.35C shows a wide data dispersion, whereas a positive trend can be seen in Figure 1.35D, meaning that the years from the end of the restoration are more relevant.

Concerning the influence of the type of restoration measure on the morphological quality increment, the data available are clearly rather limited to enable a conclusion to be reached. However, our analysis showed that removal of bank protection and widening appear to be the most effective types of measures (except for the Töss where the length of removed bank protections is too limited), while secondary channels and instream measures for habitat enhancement produce limited effects when performed alone. This is not surprising, given that the removal of bank protections and widening directly affects processes, enhancing lateral continuity and channel pattern, while secondary channels and instream measures have limited (or no) effects on processes. These considerations are summarised in Figure 1.35B, where the intervention types of the case studies are grouped into process-based (PB), form-based (FB) and in the combination of process-based and form-based (PB+FB). The figure clearly shows that process-based interventions are more effective on the enhancement of the morphological quality.

### **1.13 Conclusions**

The Morphological Quality Index (MQI) and the Morphological Quality Index for monitoring (MQIm) have been applied to eight European case studies, which included restoration measures. This allowed for the improvement of a new version of the two indices to better represent those alterations and channel morphologies which were under-represented in the original version of the MQI and MQIm, but which can occur throughout the European context.

Furthermore, these applications allowed for an analysis of the hydromorphological response to various restoration measures. Although the number of case studies is rather limited for statistically consistent analyses, some preliminary conclusions can be outlined as follows:

- (1) A significant increment of morphological quality is unlikely to be obtained by restoring river reaches already in good condition. For such cases, actions at preserving current conditions should be preferred to restoration interventions.
- (2) Sensitivity of channel morphologies is an important parameter to be considered when interventions aimed at improving hydromorphological quality are planned. An increase of morphological quality is more difficult to obtain in low sensitive morphologies, particularly in the case of measures supporting morphological changes.
- (3) Site scale interventions generally have little effect on hydromorphological conditions when considered on a scale meaningful for morphological processes (reach-scale).
- (4) Measures promoting the recovery of natural processes (process-based interventions), such as the removal of bank protection and widening, are more effective than measures recreating forms (form-based interventions).
- (5) Morphological quality is likely to progressively improve over the years following the restoration.

### **1.14 References**

- Duží B., Vikhrov D., Kelman I., Stojanov R.; Jakubínský J., 2013. Household flood risk reduction in the Czech Republic. Mitigation and Adaptation Strategies for Global Change, DOI: 10.1007/s11027-013-9504-9
- Gurnell, A.M., Bussetini, M., Camenen, B., González Del Tánago, M., Grabowski, R.C., Hendriks, D., Henshaw, A., Latapie, A., Rinaldi, M., Surian, N., 2014. A multi-scale framework and indicators of hydromorphological processes and forms. Deliverable 2.1, Part 1, of REFORM (REstoring rivers FOR effective catchment Management), a Collaborative project (large-scale integrating project) funded by the European Commission within the 7th Framework Programme under Grant Agreement 282656.
- Kail, J., Lorenz, A., Hering D., 2014. Effects of large- and small-scale river restoration on hydromorphology and ecology. Deliverable 4.3 of REFORM (REstoring rivers FOR effective catchment Management), a Collaborative project (large-scale integrating project) funded by the European Commission within the 7th Framework Programme under Grant Agreement 282656.
- Rinaldi M., Surian N., Comiti F., Bussetini M., Belletti B., Nardi L., Lastoria B., Golfieri B., 2015. Guidebook for the evaluation of stream morphological conditions by the Morphological Quality Index (MQI), Deliverable 6.2, Part 3, of REFORM (REstoring rivers FOR effective catchment Management), a Collaborative project (large-scale integrating project) funded by the European Commission within the 7th Framework Programme under Grant Agreement 282656.
- Rinaldi, M., Surian, N., Comiti, F., Bussetini, M., 2013. A method for the assessment and analysis of the hydromorphological condition of Italian streams: the Morphological Quality Index (MQI). *Geomorphology*, 180-181, 96-108.



## 2. Application of remote sensing data for hydromorphological characterization

Simone Bizzi, Luca Demarchi

JRC, ISPRA (Italy)

### 2.1 Introduction

This chapter provides a case study to show the potential of currently available Remote Sensing (RS) information to support the characterization of HYdroMORphological (HYMO) features of European river systems. The case study is the River Orco a high energy gravel bed river, tributary of the River PO in the North-West of Italy (see Figure 2.1). RS technology is more than a decade that has started to change and enrich our ability to monitor river systems and consequently to enhance our comprehension of fluvial processes (Marcus and Fonstad 2010; Carbonneau and Piégay 2012). Within the Reform's Deliverable D2.1, Annex J "Improving hydromorphological assessment by remote sensing assimilations" provides a review on the capacity and future perspectives of different remote sensing technologies to investigate different components of river hydromorphology. This chapter provides a practical implementation of some of those potentials discussed in the review. It demonstrates what can be measured using commonly available RS data at large scale in Europe to better support the characterization of river hydromorphology. The current availability of RS data is nowadays notable in Europe, and it is expected to grow enormously in the near future (Bizzi et al. 2015). However, this rich resource is not yet properly, and effectively exploited by water authorities and river managers across Europe for river hydromorphological characterization.

The chapter is so organized: first, the case study and data availability are introduced, and then the aim of the semi-automated procedure is described indicating which river HYMO features will be classified. The main steps of the RS based procedure will be introduced so to facilitate future applications. The derived classification will be then used to segment and characterize the River Orco. Potentials and research challenges about the use of RS for river hydromorphological assessments will be shortly commented in a conclusive section. A final section will link the case study method and findings with the methodological and operational tools proposed in D6.2, in particular the MQI, MQIm and GUS.

### 2.2 Study area and data

#### 2.2.1. The River Orco

The River Orco is a large Italian stream arising from the Gran Paradiso Mountains at 3.865 meters above sea level, between Aosta Valley and Piedmont regions, in the north-west of Italy (Figure 2.1). After flowing for about 80 km, it reaches the River Po. Its drainage basin area is about 900 km<sup>2</sup>, characterized by a relatively high perennial discharge, ranging from 13 m<sup>3</sup>/s in February to 45 m<sup>3</sup>/s in June. Five hydropower dams are present in the catchment. The River Orco is an alpine gravel-bed high energy river with single thread sinuous channel (meandering) in the upstream part of the catchment, which turns into a wandering type (multi-thread with vegetated and unvegetated sediment bars) forty kilometres before joining the River Po where the valley floor widens. This is the area analysed, highlighted in Figure 1 by the Disaggregated Geographical Object (DGO), which segment the river in units of 100 meter (for details see following sections).

During the 20th century, this stretch of the river experienced severe riverbed incision due to gravel mining activities, dam constructions and land use changes occurred in the basin (Turitto et al. 2010). As a consequence of the riverbed incision and channel maintenance works the wandering multi-threads river stretch was transformed into a single-thread sinuous configuration. This progress simplification of the fluvial pattern resulted in the abandonment of secondary channels, the joining of islands into the surrounding floodplain, and a significant deepening of the riverbed (1÷2 m on an average and a local maximum of 3.5 m). Gravel mining activities have been regulated and limited over the last decades and the phase of riverbed incision recently has progressively decreased. Severe floods occurred during years 1993 and 2000, which significantly modified the channel geometry showing a river tendency to recover towards a wandering pattern. Indeed, in some river reaches old channels were reactivated and morphologically active part of the channel widened significantly (Pellegrini et al. 2008).

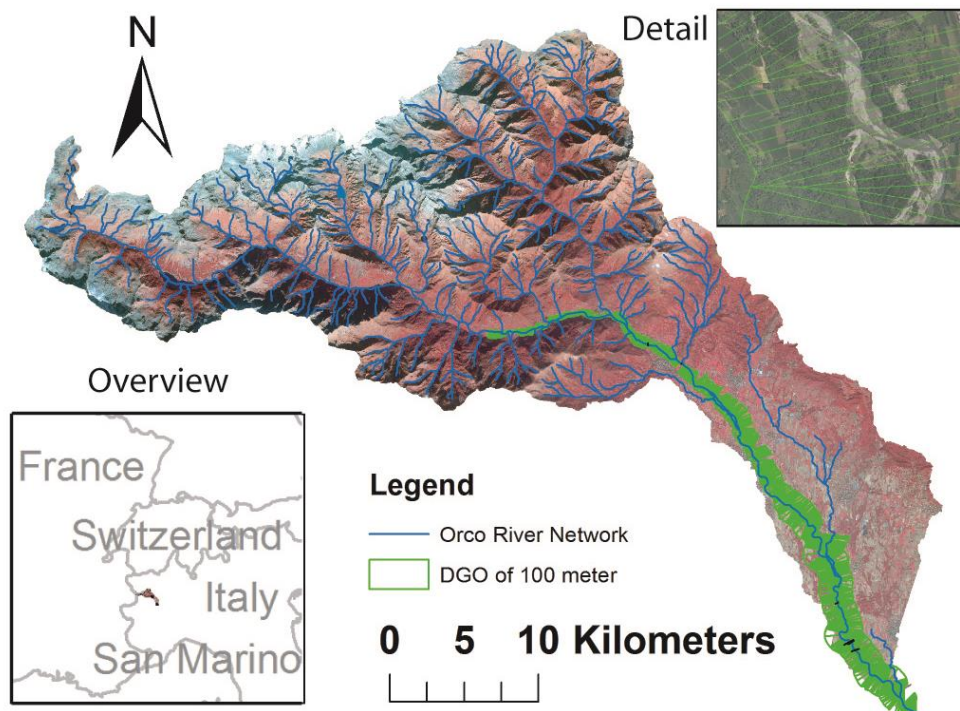

**Figure 2.1 River Orco study area. The Disaggregated Geographical Objects (DGO), which segment the river in units of 100 meter (for details see following sections), highlight the river stretch analysed.**

### 2.2.2. Classification framework: the Riverscape units

The notion of riverscape units refers to the assemblage of all those landscape elements that are relevant for describing river hydromorphology. Here, we propose a description of the riverscape functional to introduce the processing of RS information introduced in this case study. A final section will integrate the proposed indicators in the context of Reform's methods and tools developed in D2.1, D6.2, such as the MQI, MQIm and GUS.

The riverscape include all landscape elements directly affected by fluvial processes, so in particular the FloodPlain units (FPU) and the morphologically active channel, named Active Channel (AC). FPU composes the valley bottom and it is most of the time composed of alluvium sediments. FPU links the AC with surrounding terraces or hillslopes. The AC is defined in literature as the low-flow channel plus adjacent exposed sediment bar surfaces between established edges of perennial, terrestrial vegetation, which are generally subjected to erosion or deposition (Marcus et al. 2012; Belletti et al. 2013; Toone et al. 2014). Bars of bare sediments are the result of recent activities of

fluvial transport and deposition processes. In gravel-bed rivers, they are mostly composed of cobbles, gravels, and sands. The AC is then composed of the low flow water channel and unvegetated sediment bars, which composed the active part of a river channel continuously reworked by dominant floods (e.g., 1 in 2 year floods, see Figure 2.2). Here, we also define the Total Active Channel (TAC) how the AC plus bars of sparsely vegetated sediment, i.e. sediment bars which show indications of vegetation encroachment (see Figure 2.2). The process of encroachment has a key role in the evolution of alluvial islands (Gurnell et al. 2001), i.e. patches of mature vegetation surrounded by water channel and bare sediment bars. Sparsely vegetated patches appear at a first island growth stage causing sediment accretion and, if vegetation encroachment is persisting for long periods without scoured during floods, it can transform a gravel bar into a forested mature island. Forested islands are distinguishable by well-established woody vegetation, an evidence of island stability which occurred in the past years (Osterkamp 1998).

AC and TAC define the fluvial zones where morphological processes take place shaping morphological habitats of freshwater biotic communities (such as fishes and aquatic insects) and co-evolving with riparian and in-channel vegetation patches (Bertoldi et al. 2011). Their mapping over time is a key feature for understanding the morphodynamic of a river system providing at the same time a useful indicator of changes in potential ecosystem productivity (Belletti et al. 2013; Arnaud et al. 2015).

Having a precise delineation of the AC, TAC and FPU units is a first macro delineation of great importance. Such classification would allow to identify the area of channel regularly reworked by floods from, if present, FPU, which are hydrologically connected with the river but where vegetation and morphology are not primarily controlled by fluvial processes. AC, TAC and FP can be further subdivide in a number of sub-units (e.g. water channel, unvegetated sediment bars, sparsely vegetated units, and mature island) each associable to specific hydromorphological processes, as previously briefly described (more exhaustive classification are part of D6.2). The level of details of a classification is limited by the accuracy and typology (multi-spectral, hyper-spectral, LIDAR etc..) of the RS data availability and function of case specific research objectives.

During the years 2009/2010, the Regione Piemonte commissioned an acquisition of areal images to cover the entire region (25,400 km<sup>2</sup>) with 40 cm near-infrared orthophotos coupled with simultaneous topographic LiDAR data acquired at an average point density of 0.4 point/m<sup>2</sup>. Given the availability of such dataset where spectral information are coupled with topography, we propose a semi-automated procedure to map the riverscape units reported in Table 2.1 and illustrated on a reach of the River Orco in Figure 2.2. The intent is to classify water channel (WC), unvegetated sediment bars (US), and sparsely vegetated units (SVU) subdivided in riparian (RSV) and island (SVI), if completely surrounded by WC and US. Densely vegetated units (DVU) as well are divided between riparian (RDV) and island (DVI). In so doing AC, TAC and the riparian corridor can be characterized.

The main procedural challenge to develop such classifier regards the ability to discern those elements composing the active channel and then regularly reworked by floods from the floodplain units. Indeed, unvegetated sediments bars in the active channel and arable crops and bare soils in the floodplain have very similar spectral signatures, as well as patches of sparse and young vegetation in the floodplain and in the active channel. Here, the topographic information may be of support, since morphological feature in the floodplain are normally characterized by higher elevation compared to those in the active channel where erosional processes during floods take place. The following sections will present the detail of a framework to semi-automatically classify riverscape units described in Table 2.1 exploiting the available RS database in the Piemonte Region.

**Table 2.1 Riverscape units to be classified**

Riverscape Units		
Macro-Units	Sub-Units	Description
Active Channel and Total active Channel	Water Channel (WC)	Low flow water channel
	Unvegetated Sediment bars (US)	Sediment bars without vegetation
	Sparsely Vegetated units of Islands (SVI)	Sparsely vegetated units surrounded by WC and/or US.
Floodplain	Riparian Sparsely Vegetated units (RSV)	Riparian sparse vegetation units adjacent (but not surrounded) to WC or US.
	Densely Vegetated units of Islands (DVI)	Dense vegetation units surrounded by WC and/or US and/or SVI.
	Riparian Densely Vegetated units (RDV)	Riparian dense vegetation units adjacent (but not surrounded) to WC or US or RSV.
	Other Floodplain Units (OFU)	All remaining floodplain units

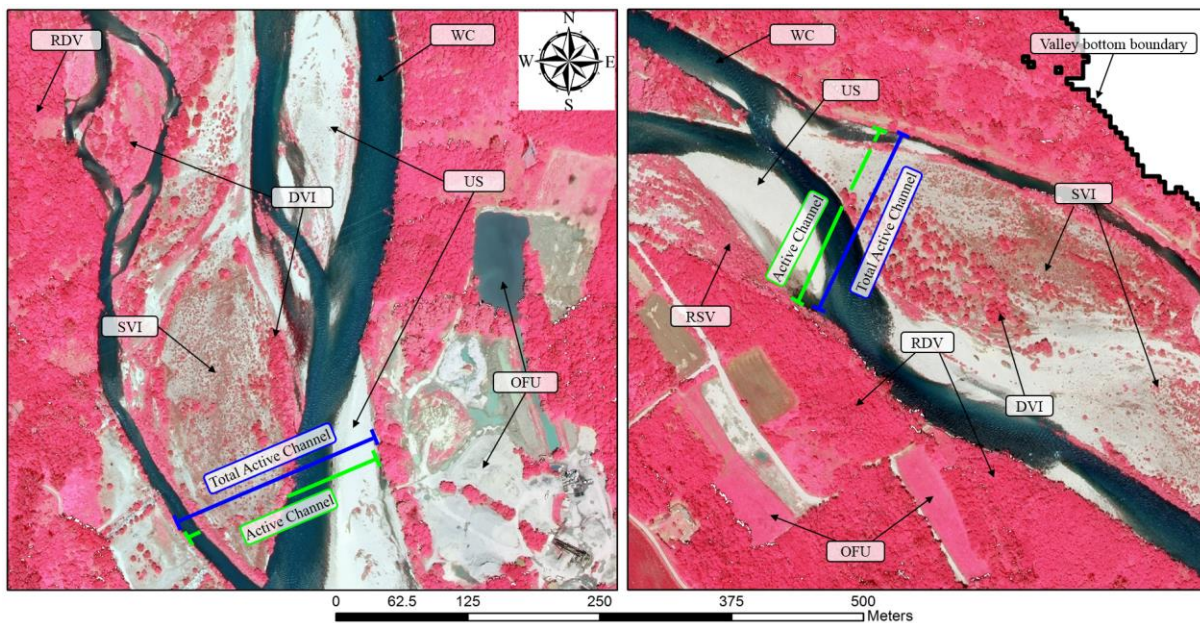

**Figure 2.2 Examples of visible riverscape units on the River Orco (Italy) from VHR imagery (false colour composite).**

**2.2.3. The Orco Case study: data availability and classification objectives**

The 40 km section of the Orco River analysed in this study corresponds to eleven tiles of 6.7\*5.7 km each of the available RS database, which were mosaicked. The different sources of RS and GIS data used for this study are resumed in Figure 2.3; data generated by the proposed procedure are showed in dotted lines.

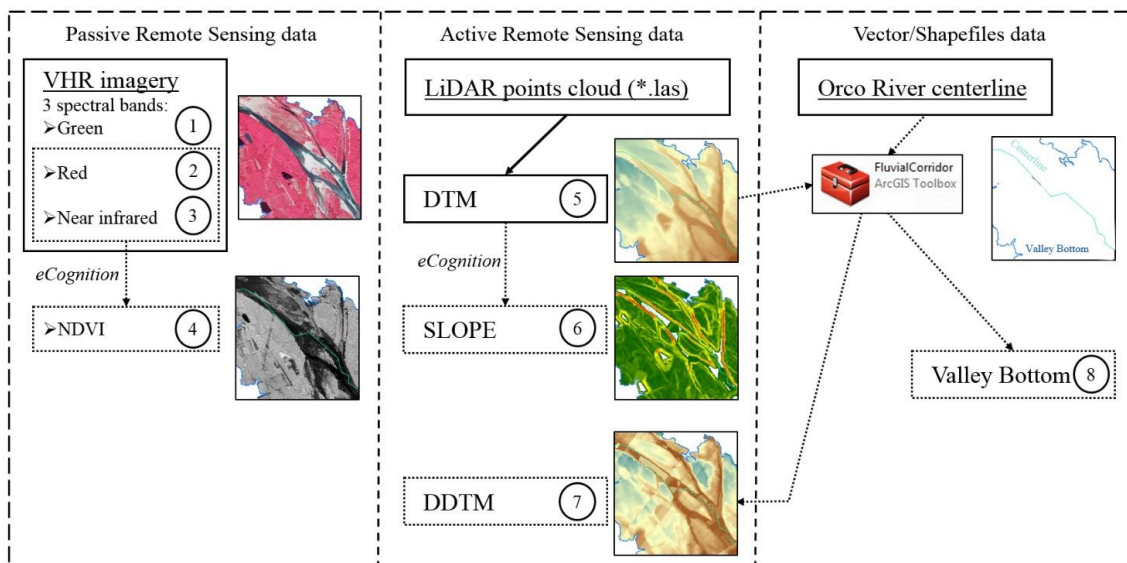

**Figure 2.3 RS and GIS input data used for this study. Input data requiring pre-processing are showed with dotted lines, while external data already available for the study are indicated with solid lines.**

The Red and Near infrared spectral bands (2 and 3, Figure 2.3) are used to calculate the Normalized Difference Vegetation Index (NDVI) (4, Figure 2.3), within the eCognition software. The data provider executed the post-processing of the LiDAR points cloud acquired during the flight, generating a Digital Terrain Model (DTM) of 5x5m grid cells (5, Figure 2.3). A quality check was also performed by the data provider, which resulted with an error of  $\pm 0.3\text{m}$  in both vertical and horizontal directions. The DTM is then used to calculate Slope (6, Figure 2.4) using the Zevenbergen-Thorne method within eCognition software (Zevenbergen and Thorne 1987). The ArcGIS “Fluvial corridor” toolbox proposed in Roux et al. (2014) is adopted in this study for the delineation of the Valley Bottom (8, Figure 2.4), defined as the modern alluvial floodplain by Alber and Piégay (2011). It is the deposition zone of alluvium, including both active channel and floodplain units. All analysis performed within this study are focused within the boundaries delineated by the Valley Bottom shapefile and therefore all raster-based data described in Figure 2.3 are accordingly clipped, neglecting everything falling outside these boundaries. The “Fluvial corridor” toolbox is also employed for the calculation of the Detrended Digital Terrain Model (DDTM), by using the Orco River centerline shapefile and the DTM. In a first step, the stream elevation is extracted along the fluvial network with a constant spatial step (disaggregated network). The DDTM is then obtained by subtracting the stream elevation from the original DTM (7, Figure 2.3). The DDTM reports the elevation of all floodplain and active channel pixels compared to the river network, and it represent a valuable topographic information describing connectivity between the low flow channel and the other riverscape units.

#### 2.2.4. Geographical object-based image analysis (GEOBIA).

The primary aim of a Geographical Object-Based Image Analysis (GEOBIA) framework is the generation of geographic information intelligence (from RS data), that enables users to develop theory, methods and tools to replicate human interpretation of RS imagery in automated/semi-automated ways, allowing for a more accurate and repeatable information, less subjectivity, and reducing labour and time costs. GEOBIA relies on RS data and generates GIS outputs, representing a critical bridge between the raster domain of RS, and the vector domain of GIS. The ‘bridge’ linking both sides of these domains is the generation of polygons, realized by grouping connected pixels having similar characteristics into meaningful image objects, an analysis technique akin the way

humans conceptually organize the landscape to comprehend it. Indeed, if carefully derived, image objects are closely related to real-world objects (Platt and Rapoza 2008). Once objects are derived, topological relationships with other objects, statistical summaries of spectral, textural values, and shape characteristics can all be calculated and employed in the classification procedure. Compared to pixel-based approaches, integrating a broad range of different object features into the analysis process is a clear advantage that might help to improve the accuracy of more advanced classification problems, like the one attempted in this study.

In this study, GEOBIA integrates VHR imagery with LIDAR-derived topographic information for the classification of riverscape units defined in Table 2.1. The entire object-based methodology is implemented within eCognition Developer 9 software. The first step is the generation of meaningful objects from the RS data, i.e. image segmentation. A multilevel hierarchical segmentation approach is proposed based on the two sources of RS data for the generation of objects as much as possible closely related to real-world objects. The first level of the hierarchical segmentation (level 1 of Figure 2.4) is produced within eCognition using the multiresolution algorithm (Benz et al. 2004) with the Slope layer alone. Thereby, different terrain features of similar slope, emerging from ongoing morphological processes of the river, might be distinguishable. A finer sub-level segmentation (level 2 of Figure 2.4) is then produced with the multiresolution algorithm, using the four spectral layers available, equally-weighted: Green, Red and Near infrared spectral bands plus NDVI (respectively layers 1,2,3 and 4 of Figure 2.3).

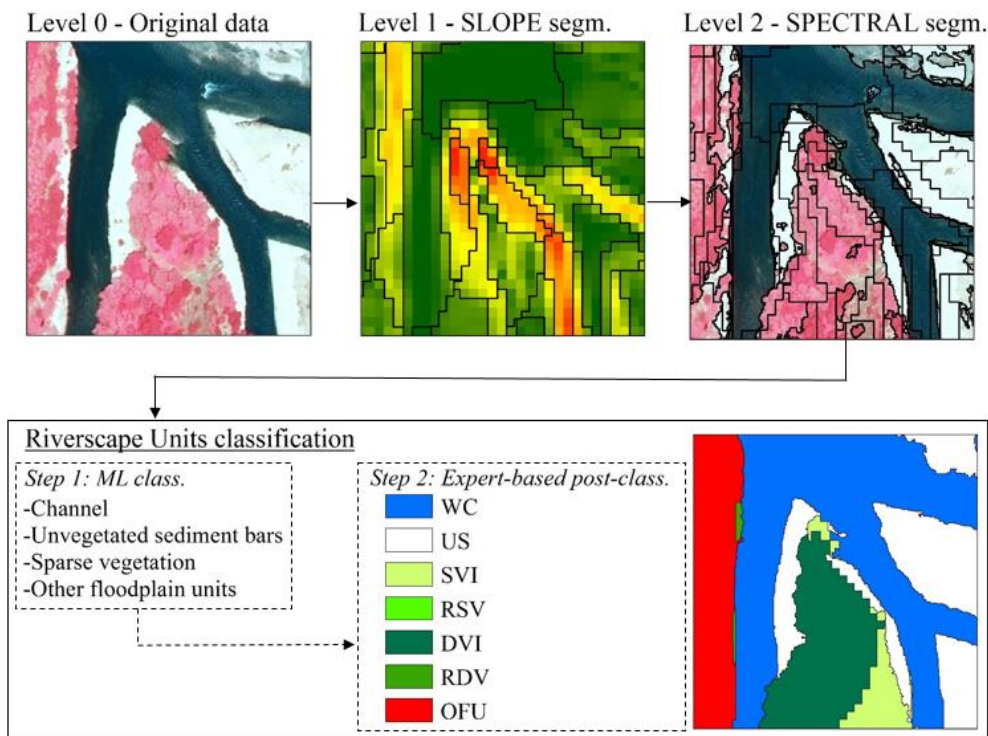

**Figure 2.4 Workflow of the multilevel, hierarchical object-based methodology developed for the classification of riverscape units.**

This step generates image objects of different spectral characteristics within bigger objects having homogenous slope features. For example, on a sediment bar identified at Level 1 by specific topographic characteristics it might be possible to distinguish pioneer vegetated patches from bare sediments or from well-established vegetated objects, characterized by different spectral values at Level 2. The two level segmentations were run with scale parameter set to 40, shape coefficient to 0.1 and compactness coefficient to 0.5. Because of the different spatial resolution of topographic and spectral data

(respectively 5 m and 0.4 m), the same scale parameter used with different input data resulted in smaller objects at the level 2 segmentation based on spectral differences. A Machine Learning (ML) object-based classification was then performed for mapping the main riverscape units on the level 2 segmentation.

### 2.2.5. Multilevel Machine Learning (ML) classification of riverscape units

A multilevel supervised classification is performed using Random Forest (RF) and Support Vector Machine (SVM) algorithms. In the field of RS, both classifiers proved to be among the most powerful Machine Learning algorithms, especially when classifying high-dimensional datasets. In literature, they are mostly used as pixel-based classifiers, whereas little attention has been paid to their implementation to object-based approaches (Tzotsos and Argialas 2008).

Object features are derived from level 2 segmentation a grouped in the four categories of Step 1 reported in Figure 2.4. Sample objects are collected based on visual interpretation of VHR imagery following Wiederkehr et al. (2010), for the following classes: "Water Channel" (WC), "Unvegetated Sediment bars" (US), "Sparse Vegetation Units" (SVU), "Floodplains Units" (FPU). Traditionally active channels and its units are manually mapped on the Orthophotos by expert based visual interpretation. WC, US and SVU are units easy to be mapped since or water is flowing or visually present evidences of recent morphological work due to recent floods, e.g. unvegetated and sparsely vegetated sediment bars. This first step of classification allows to delineating the border between the active channel and the surrounding floodplain. The classification of more detailed units defined in Table 2.1, e.g. SVI, DVI, RSV, and RDV, will be derived automatically by a set of GIS-based rules from this first step classification (the procedure is described in the following sections).

Different combinations of object features are tested with the aim of assessing which produce the highest classification accuracies. Table 2.2 illustrates the different sets of input features calculated. From the VHR imagery, ten VHR features (1) are extracted by eCognition software: mean and standard deviation of the four spectral layers (1 to 4 of Figure 2.3), plus brightness and max difference. From the LiDAR-derived products, we grouped the mean and standard deviation of the DTM and Slope, respectively layer 5 and 6 of Figure 2.3, as LiDAR set (2), while the mean and standard deviation of the DDTM, layer 7 of Figure 2.3, as the DDTM set (3). Fifteen Geometric features (set 4) and twelve Texture features (set 5) are calculated by the eCognition software using both GLCM and GLDV approaches. For a more detailed explanation on the texture and geometric features calculation, the reader is referred to Trimble (2014).

**Table 2.2 Input feature sets used for training different RF and SVM classifiers.**

1. VHR	2. LIDAR	3. DDTM	4. Geometric	5. Texture
<p><u>Mean:</u> Green, Red Near Infrared, NDVI, Brightness, Max difference</p> <p><u>Standard deviation:</u> Green, Red, Near Infrared, NDVI</p>	<p><u>Mean:</u> DTM, SLOPE</p> <p><u>Standard deviation:</u> DTM, SLOPE</p>	<p><u>Mean:</u> DDTM</p> <p><u>Standard deviation:</u> DDTM</p>	<p>Area, Border length, Length, Length/Width, Width, Asymmetry, Border index, Compactness, Density, Elliptic fit, Radius of largest enclosed ellipse, Radius of smallest enclosing ellipse, Rectangular fit, Roundness, Shape index</p>	<p>Homogeneity (GLCM), Contrast (GLCM), Dissimilarity (GLCM), Entropy (GLCM), Angle of 2<sup>nd</sup> moment (GLCM), Mean (GLCM), Standard deviation (GLCM), Correlation (GLCM), Angle of 2<sup>nd</sup> moment (GLDV), Entropy (GLDV), Mean (GLDV), Contrast (GLDV)</p>

Table 2.3 lists the number of samples collected. FPU have much higher extension than the other units, and therefore the number of samples collected for this class is higher. The training samples collected for the FPU covers 19% of the entire analysed area, while the validation samples covers 15% of the total area. Considering the other three classes, the training samples represent about 28% of the whole area, while the validation samples about 23% . Machine learning classification with RF and SVM is performed using different combinations of input features sets (Table 2.2), calculated for the level 2 objects (see Figure 2.4). Validation objects are used for the accuracy assessment, based on Kappa values and per-class producer accuracy comparison.

**Table 2.3 Training and validation samples collected by visual interpretation of VHR imagery and corresponding covering areas.**

	Training			Validation		
	samples	Area (km <sup>2</sup> )	percentage	samples	Area (km <sup>2</sup> )	percentage
<b>US</b>	2950	0.74	2.46%	1990	0.73	2.44%
<b>WC</b>	2556	1.07	3.56%	1504	0.92	3.08%
<b>SVU</b>	2919	0.74	2.47%	1736	0.65	2.18%
<b>FPU</b>	21761	5.71	19.03%	18827	4.56	15.20%
			27.53%			22.91%

## 2.3 Classification Results

### 2.3.1. Riverscape units classification results.

Figure 2.5 shows the Kappa accuracies resulting from RF and SVM using different combinations of input features sets. In general, accuracies are very similar for both classifiers, underlying the capability of both ML classifiers to map riverscape units with accuracies in most cases above 0.70. When classifying the ten VHR features, both RF and SVM generate the same Kappa accuracy of 0.79. When the topographic features are utilised alone without any spectral information (LiDAR features and DDTM features, respectively sets 2 and 3, see Table 2.2, for a total of 6 features), the Kappa accuracy is significantly lower (0.59 for SVM and 0.60 for RF). This is an expected result since spectral information is required for distinguishing sparsely vegetated classes, bare sediments, and water channel within the active channel. Indeed, when combining the spectral features with the topographic ones, Kappa value increases. VHR features together with the LiDAR features (sets 1 and 2 of Table 2.2, for a total of 14 features) produce a Kappa value of 0.81 for the SVM and 0.78 for the RF. Better performances are generated using DDTM features (set 3, Table 2.2) with the VHR features (set 1, Table 2.2), which have a kappa value of 0.91 for SVM and 0.89 for RF. Using both LiDAR and DDTM features together with the VHR features (sets 1, 2, and 3), generates accuracies slightly lower (0.88 for SVM and 0.85 for RF), that might indicate the limits of the algorithms in features selection in presence of an elevate number of co-varying inputs. When the VHR features are used in combination with the Geometric features (respectively sets 1, and 4, 25 features in total) the accuracy is still relatively high for the RF (0.81) while slightly lower (0.76) for the SVM, showing the limits of SVM in exploiting the Geometric features for this specific classification problem. When VHR features are used with Texture features (respectively groups 1 and 5, 22 features in total) both classifiers generate a Kappa value of 0.84.



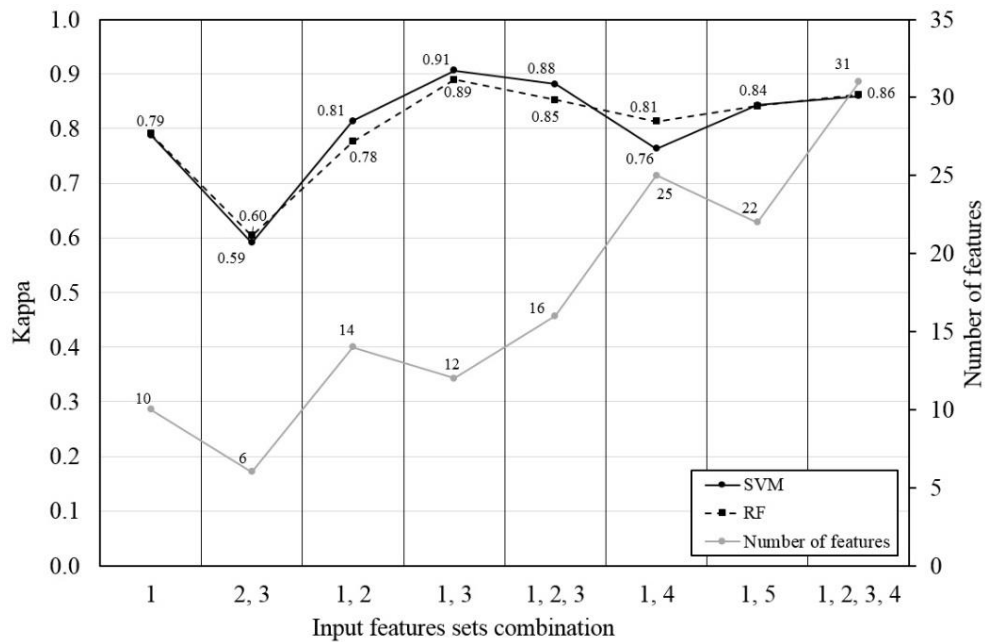

**Figure 2.5 Riverscape units classification results obtained when testing different input features sets combination (see Table 2 for details of variables in each set) with SVM and RF.**

These results point out the relevance of DDTM (layer 7 of Figure 2.3) for the scope of this classification. Mean and standard deviation of this layer calculated for each object and combined with mean and standard deviation of other spectral layers (layers 1-4 of Figure 2.3) are sufficient to generate the highest Kappa accuracy. The DDTM layer is more important than Geometric features and Texture features.

The most efficient result in terms of Kappa, PA and number of input features is produced by SVM using VHR and DDTM features (sets 1, and 3 see Figure 2.5). This result is therefore used for a post-classification step aiming at improving the classification accuracy. Commission and Omission Errors are analysed (see Table 2.4 and Table 2.5) for this classifier in order to understand where most of the errors occur and therefore removing them in a post-processing phase. The highest Commission Error (CE) occurs for SVU and equals 17.25% (see Table 2.4), which means that 17.25% of the pixels classified as SVU should have been instead classified into other classes, in this case 15.77% of them into FPU, 1.23% in WC and 0.25% into US. This high error rate is due to the fact that some floodplain objects are composed of sparse vegetation patches or other land uses with a similar spectral signatures, which have also an elevation not significantly different from the active channel.

The highest Omission Error (OE) is again for SVU and equals 21.37 % (see Table 2.5), which means that 21.37% of the SVU are misclassified as: 19.11% FPU, 1.58% US and 0.67% WC. This misclassification occurs predominantly for the vegetation patches located within the active channel, underlying some limits of the classifier in discerning between sparse and mature vegetation units. This type of error for the sake of this specific classification can be considered less significant, since it creates only some uncertainty in defining a threshold between sparse and dense vegetation patches.

**Table 2.4 Commission Errors (CE) produced by SVM when classifying riverscape units using VHR and DDTM features before (above) and after (below) the post-classification.**

<u>CE before post-classification</u>	<b>Total</b>	<b>FU</b>	<b>US</b>	<b>WC</b>	<b>SVU</b>
<b>FPU</b>	3.37	--	0.45	0.19	2.74
<b>US</b>	7.16	4.65	--	1.15	1.35
<b>WC</b>	2.13	1.51	0.15	--	0.48
<b>SVU</b>	17.25	15.77	0.25	1.23	--
<u>CE after post-classification</u>	<b>Total</b>	<b>FU</b>	<b>US</b>	<b>WC</b>	<b>SVU</b>
<b>FPU</b>	2.12	--	0.23	0.17	1.73
<b>US</b>	3.87	1.07	--	1.29	1.51
<b>WC</b>	1.41	0.78	0.15	--	0.48
<b>SVU</b>	4.98	3.31	0.30	1.37	--

**Table 2.5 Omission Errors (OE) produced by SVM when classifying riverscape units using VHR and DDTM features before (above) and after (below) the post-classification.**

<u>OE before post-classification</u>	<b>Total</b>	<b>FU</b>	<b>US</b>	<b>WC</b>	<b>SVU</b>
<b>FPU</b>	3.23	--	0.78	0.30	2.15
<b>US</b>	3.19	2.80	--	0.18	0.21
<b>WC</b>	2.70	0.92	0.95	--	0.83
<b>SVU</b>	21.37	19.11	1.58	0.67	--
<u>OE after post-classification</u>	<b>Total</b>	<b>FU</b>	<b>US</b>	<b>WC</b>	<b>SVU</b>
<b>FPU</b>	0.74	--	0.18	0.16	0.40
<b>US</b>	1.85	1.43	--	0.19	0.23
<b>WC</b>	2.65	0.83	1.03	--	0.80
<b>SVU</b>	15.39	12.84	1.82	0.73	--

The post-classification step is developed to lower the highest CE and OE and to classify the riverscape units as define in Table 2.1. To do so, a number of rulesets are developed following an expert-based approach, under eCognition software. These rules are case specific and easy to be implemented. For instance, the CE for US is removed by imposing two threshold conditions: distance to WC  $\geq 200$  pixels and Mean DDTM value  $\geq 250$  cm. Similarly rules are implemented for CE of SVU. Objects satisfying these conditions are labelled as FPU. In so doing the Kappa accuracy is increased from 0.91 to 0.95, the total CE of SVU lowers from 17.25% to 4.98% (Table 2.4), and at the same time the OE from

21.37% to 15.39% (Table 2.5). For US the total CE is decreased from 7.16% to 3.87%, (Table 2.4) while the OE from 3.19% to 1.85% (Table 2.5).

Therefore, the post-classification phase is an important resource for deleting this kind of bias, which at some locations cannot be eliminated exploiting the spectral and topographic information alone due to case specific peculiarities. Although this object-based rule-set architecture developed is case-specific and could be influenced by operators' subjectivity, it proves to be very efficient and flexible: designing ad-hoc solutions suitable to solve specific classification problems is relatively simple. A manual deletion of mistaken objects could also be carried out with moderate efforts, since the misclassified objects are easily spotted in the image and can be effectively selected manually. This is thanks to the GEOBIA approach that organizes the information in morphological and spectral meaningful object easy to be visually interpreted and manually selected. This is a notable capability to support more widely the use of object-oriented approaches within water authorities to store and manage river RS based datasets.

Finally, in order to derive the class described in Table 2.1 it is sufficient to implement some simple GIS-based rules on the four classes defined by the machine learning (ML) application, see Figure 2.6 for an examples: going from Step 1 to Step 2 requires simple spatial criteria. SVU is defined as SVI, i.e. island of sparsely vegetated units, if the objects are completely surrounded by WC and/or US. The remaining objects are classified as riparian sparsely vegetated (RSV), since located in the interface between the active channel and the floodplain units. FPU completely surrounded by WC and/or US and/or SVI are classified as DVI, since they represent densely vegetated patches higher in elevation compared to the rest of the active channel. Finally we use the NDVI index for identifying densely vegetated patches within the floodplain and if these objects are connected to WC or US or RSV objects are classified as riparian densely vegetated patches (RDV). In so doing, the riparian, sparsely or densely, vegetated corridor along the river course is mapped.

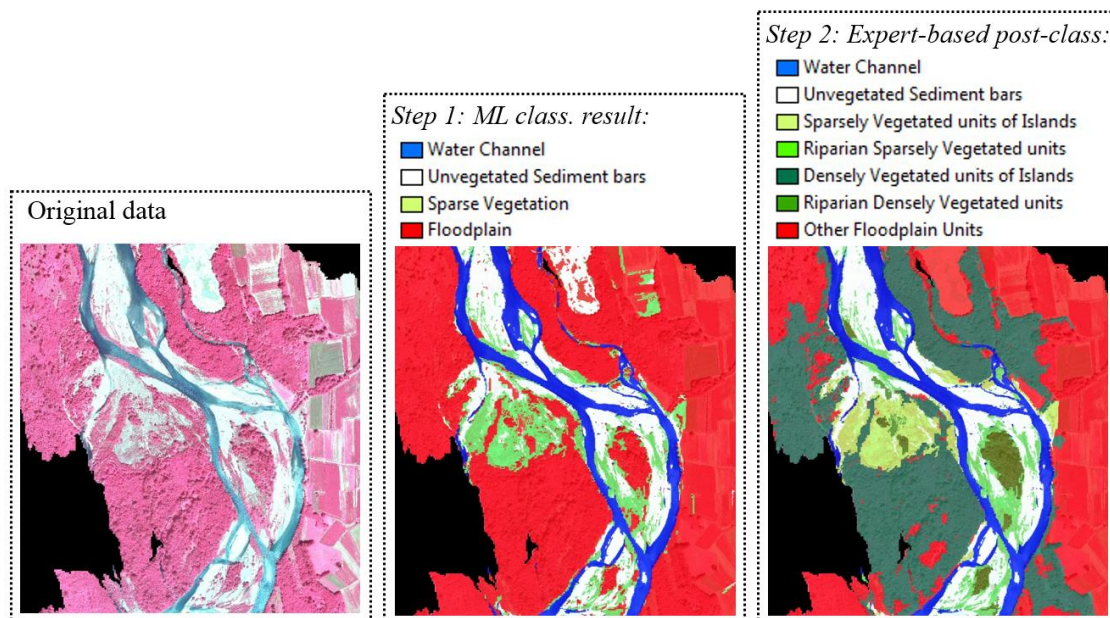

**Figure 2.6 Example of riverscape units classification: Step 1 is generated by the machine learning (ML) classifier, whereas Step 2 starting from the classes of Step 1 maps the units defined in Table 1 through the application of a set of GIS-based rules.**

## **2.4 Potential of the methodology for large scale (basin, regional) applications in Europe**

The classification framework proposed generates a continuous mapping of key HYMO variables along the river course. Similar results traditionally have been produced drawing manually polygons around the HYMO features of interest, which have allowed to exploit historical orthophotos and then analyse the historical trajectories of fluvial processes (Liébault and Piégay 2001; Bollati et al. 2014). For future applications based on more accurate and information rich RS datasets such manual approach is limited. First, it is more time consuming and biased by the operator subjectivity: different operators may generate different type of classification for similar classes. For instance, when discerning if a sediment bar is sparsely or densely vegetated. Moreover, manual editing of features is based purely on areal information of the orthophotos and the border between different object does not include any accuracy regarding topography. If this precision can be accepted for assessing areal extent of HYMO features it misses out all topographic characterization of the object. The proposed framework, thanks to the GEOBIA technology, allows the definition of objects that integrate topographic and spectral information by a hierarchical segmentation, see Figure 2.4. Consequently the generated objects are meaningful for the derivation of areal and topographic HYMO variables (see next section on the River Orco characterization for an example). Moreover, the final classification is based on quantitative thresholds of RS information and then objective and repeatable across space and time. Such advances open new opportunities in terms of river characterizations. For instance, the dataset analysed for this study is part of a bigger dataset covering the whole Regione Piemonte with the same type of RS data (VHR imagery and LiDAR). The application of the classification framework at the regional scale is a natural step, which is being undertaken. More in general, a recent review of Bizzi et al. (2015) points out the unexploited potential of already existing RS datasets for the hydromorphological characterization of European river systems, and discuss the fact that in river science and management a current priority is to invest on data processing and management because the amount of RS data which is being (and will be) produced is unprecedented.

## **2.5 Hydromorphological characterization of the River Orco**

### **2.5.1. Hydromorphological variables derivations**

In this section we provide an example of river HYMO characterization, which can be produced using the riverscape units classified in the previous section. We adopt the methodology proposed by Alber and Piégay (2011) disaggregating the valley bottom, composed of all riverscape units classified, in river units of 100 meter calculated along the length of the river network shapefile (see Figure 2.1). These units, named Disaggregated Geographical Object (DGO), represent the basic unit of this analysis. Table 2.6 reports the HYMO variables analysed, which have been derived every DGO using the riverscape units defined in Table 2.1.

The first two variables describe the attribute of the channel here, slope and confinement. Channel slope is calculated from the LIDAR derived DEM at 5 m resampled at 25 m to avoid over sinuosity adopting the method proposed by Biron et al. (2013). Channel confinement is calculated as the ratio between the active channel area, here composed of WC e US, and the valley bottom area. These HYMO variables characterize the river energy (slope) and its degree of freedom to laterally move in order to adjust the channel size to the incoming water and sediment fluxes. The other HYMO variables are directly derived from the classes defined in Table 2.1: areal extent and topographic variables, namely percentile 16, 50, 84 of DDTM, are calculated for different riverscape units. Percentiles of DDTM provide the elevation of unvegetated and vegetated sediment bars from the water channel and the degree of (dis)-connectivity of water channel from the

floodplain units. This dataset provides valuable information to characterize river functional types not only in terms of frequency, typology and extent of fluvial forms, as traditionally done analysing orthophotos of river stretches (Liébault and Piégay 2001; Bollati et al. 2014), but also in terms of topographic dimension. It means being able to characterize the degree of connectivity between different channel forms enhancing our ability to identify and characterize the fluvial morphological processes that sustain those forms.

**Table 2.6 HYMO variables derived every DGO of 100 meter (see Figure 1). See Table 1 for acronyms on riverscape units adopted.**

HYMO variable	Acronym	Description
<i>Slope</i>	SL	Channel slope calculate every 25 m, resampling the DEM at 5 m to avoid over sinuosity following the method of Biron et al. (2013)
<i>Confinement:</i> $(WC+US)/$ $(WC+US+SVI+RSV+DVI$ $+RDV+OFU)$	CONF	Ratio of Active channel and valley bottom
<i>Unvegetated Sediment Bars ratio:</i> $US/(US + WC)$	US*	Area of HYMO features normalized by the active channel
<i>Sparsely Vegetated sediment Bars ratio:</i> $(SVI + RSV)/(US + WC)$	SVB*	
<i>Densely Vegetated Islands ratio:</i> $DVI/(US + WC)$	DVI*	
<i>Unvegetated Bars: US</i>	USp16, USp50, USp84	Altitude [m] of HYMO features from the water channel as derived from DDTM. For each feature 16, 50, 84 percentiles are calculated.
<i>Sparsely vegetated bars: SVI + RSV</i>	SVBp16, SVBp50, SVBp84	
<i>Densely Vegetated Islands: DVI</i>	DVIp16, DVIp50, DVIp84	
<i>Floodplain: RDI+OFU</i>	FPp16, FPp50, FPp84	

In this application in terms of riverscape units definition compared to Table 2.1 there is a difference concerning sparse vegetation. For the scope of this analysis RSV and SVI have been merged together. Sparsely vegetated patches appear at a first island growth stage causing sediment accretion and, if vegetation encroachment is persisting for long periods without scoured during floods, it can transform a gravel bar into a forested mature island (Gurnell et al. 2001). For this analysis of the River Orco the interest is on the extent and topography of sparsely vegetation patches (RSV and SVI) around the water channels and unvegetated bars (WC and US), and afterwards on identifying those areas where these patches stabilized in proper forested island (RDV). The analysis of other combinations of the classes defined in Table 2.1 can be equally suitable and the choice is very much case dependent on the sake of research questions or management objectives pursued. For this reason the classification step pursued in the previous section should be as detailed as possible and limited by the RS accuracy and richness of information. The characterization phase will then make the best use of this classification based on the analysis needs.

The variables in Table 2.6 provide information on areal and topographic features of the river course so to allow a details characterization of the development of fluvial forms from upstream to downstream. The first step of the characterization generates a segmentation of the river course based on the active channel, defined as the sum of WC plus US. It is well established in literature that the active channel is a sensitive parameters which significantly varies for different river functional types or various degree of anthropic pressures acting on the river course (Alber and Piégay 2011; Bertrand et al. 2013). For this reason, it is judged a suitable variable to generate a first segmentation of homogeneous river reaches. We adopted the Hubert test as proposed by Leviandier et al. (2012) to detect segments characterized by the highest differences in terms of population samples, i.e. a subdivision of reaches for which the values of active channel area every DGO generate distribution probabilities with the highest differences in between reaches. Figure 2.7 shows the 8 reaches generated by the Hubert test on the 40 km of the River Orco analysed, see the DGO in Figure 2.1 to locate the stretch of the river analysed. It represents the lower course of the River Orco when the valley opens until it flows into the River PO. For each segment Figure 2.8 and Figure 2.9 report the boxplots of the HYMO variables. Some patterns clearly emerge: upstream segments have higher slope (SL) and degree of confinement (CONF), middle segments, such as 4 and 5, have higher density of sparsely vegetated patches (SVB\*), whereas lower segments, such as 6 and 7, have the highest density of unvegetated sediment bars (US\*) in the active channel (see Figure 2.8). In terms of topography there is a general trend of higher elevation for all riverscapes units in upstream reaches compared to downstream ones (see Figure 2.9).

A hierarchical clustering analysis is then perform to quantify the difference amongst the 8 reaches in the multi-dimensional spaces including all HYMO variable of Table 2.6 but selecting only the percentile 84 for topographic variables. This choice is done in order to do not overestimate the importance of topographic features (12 variables, 4 features for three percentiles see Figure 2.9) compared to areal ones (3 features plus slope and confinement, see Figure 2.8). Results are reported in Figure 2.10, and Figure 2.11 shows pictures of three representative reaches 2, 4 and 7. Flowing downstream the river shifts from a single thread sinuous type to a wandering typology. This shift triggers a change in topographic and areal HYMO features as described by Figure 2.8 and Figure 2.9. It is a gradual variation well mapped by the hierarchical clustering in Figure 2.10 where the difference amongst reaches has been quantified.

It is worth noting how the analysis spots incoherence compared to what should be expected in an unaltered river system with a natural progression from upstream to downstream. For instance, reaches 5 and 8 have lower density of unvegetated and sparsely vegetated bars compared to 6 and 7. Indeed, reaches 5 and 8 present higher density of river infrastructures (mainly bridges and bank protections) compared to 6 and 7 that conversely are relatively free to laterally move and adjust the channel planform. A similar comment stands also between reaches 1 and 2. The latter shows significantly lower density of unvegetated bars although possessing similar degree of confinement, and in particular riverscape units have lower connectivity (i.e. higher elevation) with the water channel compared to reach 1. Indeed, Reach 2 is more densely artificialized, and here the river bed have incised more severely in the last 30 years compared to the surrounding ones (Rosso et al. 2008). Moreover, as briefly mentioned in the case study introduction, severe floods occurred during years 1993 and 2000, they significantly modified the channel geometry showing a river tendency to recover towards a wandering pattern from sinuous single thread typology. This latter typology is the results of a phase of severe river bed degradation triggered primarily by gravel mining in the sixties and seventy (Pellegrini et al. 2008). The river segments that have reported the highest rate of widening and recovery

correspond to reaches 6 and 7 in this analysis. These reaches have higher connectivity to the water channel (in particular for US and SVU classes) compare to upstream and downstream reaches (see Figure 2.9).

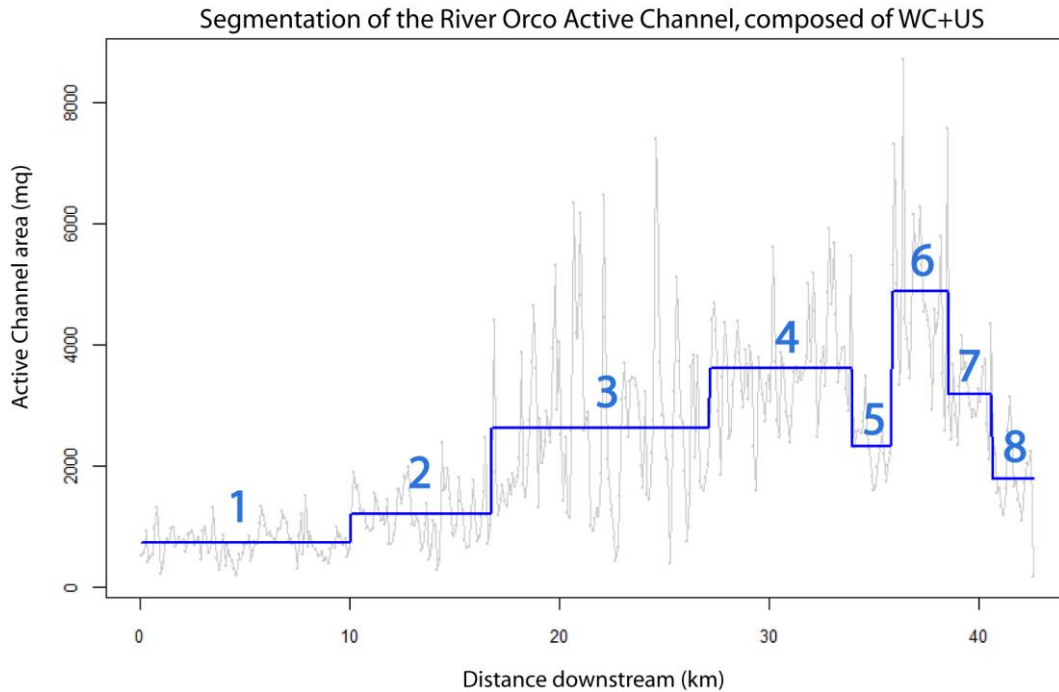

**Figure 2.7 Semi-automated river segmentation based on Active Channel implementing the Huber test. Eight river reaches are identified.**

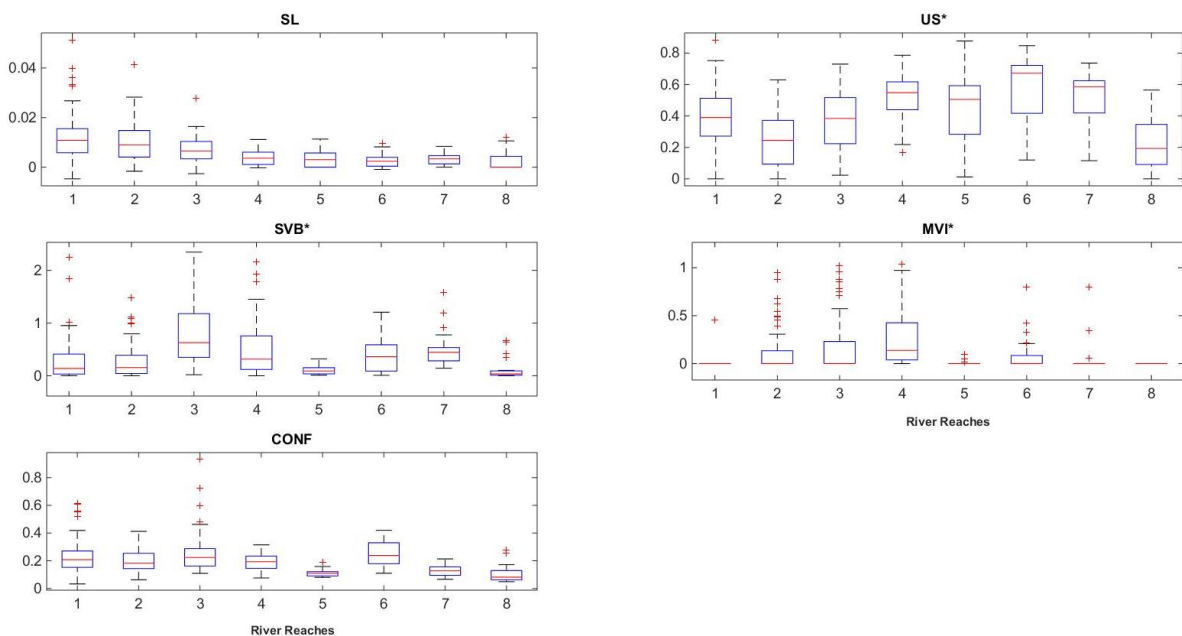

**Figure 2.8 Dimensionless SL, US\*, SVB\*, MVI\* and CONF for every river reach. For variables definition see Table 6.**

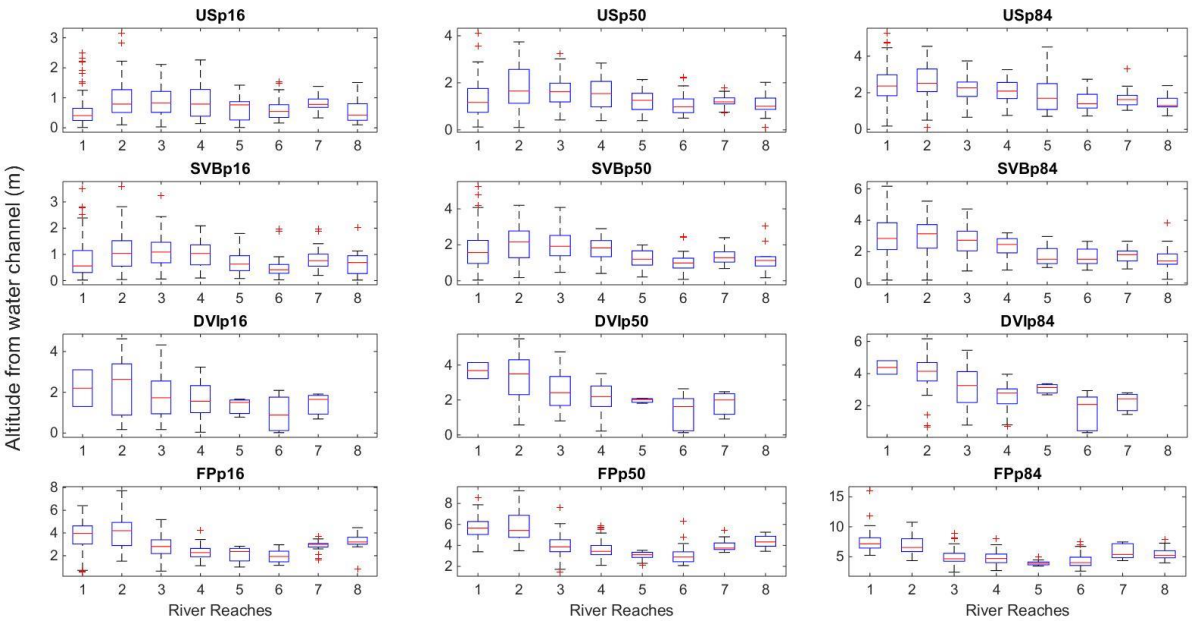

**Figure 2.9 Topographic HYMO variables defined in Table 6 for each river reach.**

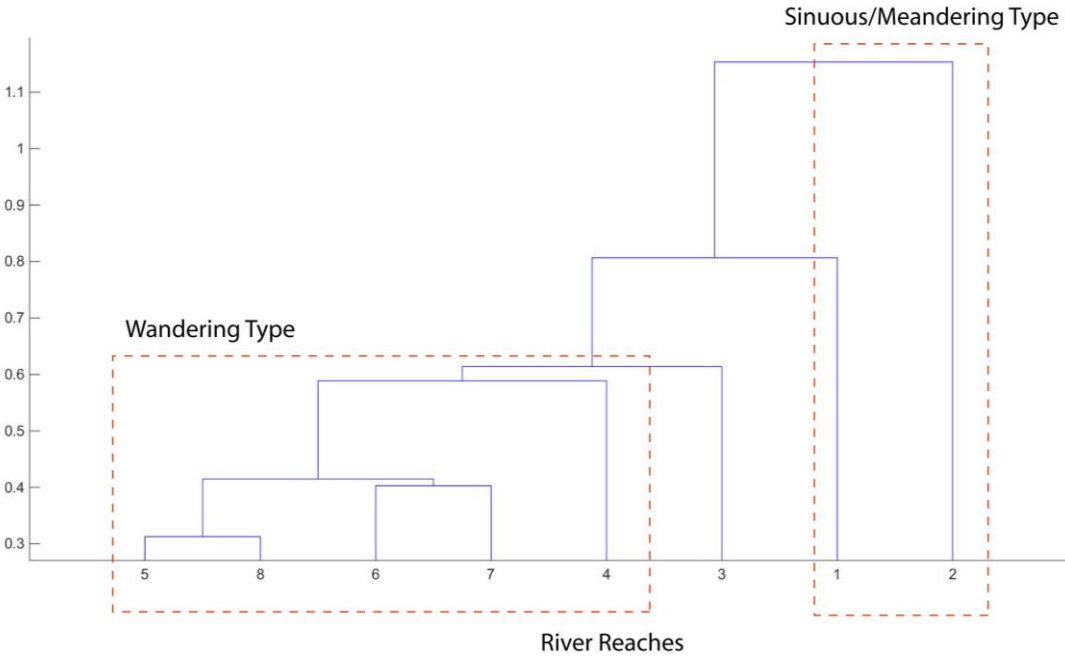

**Figure 2.10 Hierarchical clustering on river reaches using as input features the HYMO variables defined in Table 6. Two main river functional types emerge.**





**Figure 2.11 Orthophotos of reach 2, sinuous single thread, and reaches 4 and 7, wandering type (scale 1:1000). Green lines plot the DGO sequences.**

### 2.5.2. Conclusions

These findings demonstrate a number of abilities of RS data to enrich traditional river HYMO assessments based primarily on scattered field campaigns and manual editing of Orthophotos. First, river segmentation together with identification and definition of river functional types can be semi-automatized and it is based on quantitative indicators measured every 100 m continuously over the river course (see Figure 2.7, Figure 2.8, Figure 2.9 and Figure 2.10). The criteria to be adopted for the segmentation can be many, and case specific. However, once they are commonly defined segmentation can be objective, repeatable and applicable on large scale with moderate efforts. That guarantees robustness, and comparability of the classifications. This is an urgent need of modern river management especially in Europe with the WFD (EC 2000) where comparability at high level planning is required for allocating resource, and for prioritizing measures on reaches with higher potential of ecological rehabilitation or vice-versa for localizing heavily modified waterbody (HMWB) subject to less stringent environmental objectives. The semi-automated segmentation together with the RS generated HYMO variables are able to quantify the transition in river functional types, e.g. in the case study from single thread sinuous to wandering. The characterization generated is also able to distinguish between reaches affected by different degree of alterations within the same functional type, see for instance the difference between reaches 1 and 2 and between 6 and 7 compared to 5 and 8.

The possibility to integrate topographical information with areal ones opens important capacity to monitor river processes and forms. The proposed case study is a first attempts in this direction and has provided some evidences of interest. In particular, reach 2 shows lower level of connectivity of vegetated and unvegetated sediment bars to the water channel, which may indicate a recent trends of river bed incision. If channel bed lowers the elevation between water channel and sediment bars is supposed to increase. A similar comment can be made for segments 6 and 7, which have been reported to be in a phase of widening, aggradation and recovery (Pellegrini et al. 2008). This is coherent with higher level of connectivity reported by USp and SVBp for these reaches compared to surrounding ones, see Figure 2.9. The severity of such fluvial processes may be monitored in the near future by indicators such as USp and SVBp through several acquisitions. Similar indicators based on field campaigns measuring river bed relief, i.e. cross section variance in morphometry, have been already successfully adopted to determine the degree of degradation or recovery of braided rivers in France (Liébault et al. 2013). Providing similar assessment indexes based on remote sensing data would represent a major advance for river monitoring especially for the potential to cover large areas such as, regional or national.

Indeed, it is evident that the main advantage of RS approach to river HYMO characterization will emerge with large scales applications and when sequential acquisitions will be available (in the near future) to start monitor morphological processes. RS data for the first time offer the possibility to generate data at basin and beyond regional scales opening to the possibility to create structured geo-database of HYMO data. Soon, it will be possible to systematically compare river functional types across basins with the same metrics and to investigate those drivers like hydrological forcing, sediment supply, and historical contingency responsible for these differences (Phillips 2010). All that will allow to setting quantifiable river management targets and to effectively monitoring the rate of success of the implemented measures. There are major potentials to enhance our ability to monitor and characterize river systems in the near future thanks to RS data, which are just starting to be exploited. Nowadays the bottleneck for better support river management and advance in river science is not in data generation (as it was in the past), whereas on the contrary it is in the current ability of river managers, practitioners and researches to exploit coming RS information.

### **2.5.3. Linking the case study with Reform HYMO assessment methods and tools**

The proposed case study presents an illustrative example about current potentials offered by RS data for deriving relevant HYMO features. Reform's reports D2.1 and D6.2 provide an exhaustive overview of methods and tools for the characterization and classification of European river systems. In particular D6.2 provides a set of operational tools, like a guidebook for the evaluation of stream morphological conditions (MQI) and another for the Geomorphic Units survey (GUS), where fluvial types and forms at multiple scales have been clearly defined using a coherent terminology and a common ground of scientific understanding on fluvial processes (mainly developed in D2.1). It is out of the scope of this chapter to demonstrate how much RS may fulfil these tools, such as MQI and GUS. However, RS technology has clear potential to feed these operational tools as it is clearly stated in their respective guidebooks.

The River Orco case study is an example of such potential and although we did not calculated MQI and GUS indicators, the indicators proposed are based on a common scientific understanding of fluvial processes. It is for this reason, for instance, that the segmentation of the River Orco uses the word "reach" to refer to a base river unit to be analysed (see Figure 2.7), as proposed by the hierarchical framework developed in D2.1 and D6.2, and implemented in the MQI. The reach unit is defined as "section of river along which boundary conditions are sufficiently uniform that the river maintains a near consistent internal set of process-form interactions". Indeed, that is what has been quantified through a statistical analysis applied to RS derived information. The delineation of spatial units required by MQI may be potentially addressed by a hierarchical clustering of the segmented river reaches if the RS classification was available at the entire river network scale. Data is already available for this task, and similar attempts already exist in literature (Schmitt et al. 2014). Moreover, the indicators calculated in Table 2.1 can feed many indicators proposed in the MQI and in the broad levels of the GUS. In particular when sequential acquisitions of RS data will be available and it will be possible to monitor rate of river processes the potential to feed the MQI and MQIm tools will be notable. However, the use of RS for river characterization it is not, and it will never be, a substitute of field campaigns. Going to the field provides some measures, and more importantly, an understanding of river processes, which cannot be substituted solely by RS technology. Notwithstanding that, it is a fact that RS information is changing the way we look at river systems opening unprecedented opportunities (Marcus and Fonstad 2010; Carbonneau and Piégay 2012). It is a priority for river managers to integrate valuable tools like MQI and GUS with state of art RS technology in terms of data production and analysis. Such integration will compose the base of future river management.

## 2.6 References

- Alber, A., Piégay, H., 2011. Spatial disaggregation and aggregation procedures for characterizing fluvial features at the network-scale: Application to the Rhône basin (France). *Geomorphology* 125, 343–360.
- Arnaud, F., Piégay, H., Schmitt, L., Rollet, a. J., Ferrier, V., Béal, D., 2015. Historical geomorphic analysis (1932–2011) of a by-passed river reach in process-based restoration perspectives: The Old Rhine downstream of the Kembs diversion dam (France, Germany). *Geomorphology* 236, 163–177. doi:10.1016/j.geomorph.2015.02.009
- Belletti, B., Dufour, S., Piégay, H., 2013. What is the Relative Effect of Space and Time to Explain the Braided River Width and Island Patterns at a Regional Scale? *River Res. Appl.* 31, 1–15. doi:10.1002/rra.2714
- Benz, U.C., Hofmann, P., Willhauck, G., Lingenfelder, I., Heynen, M., 2004. Multi-resolution, object-oriented fuzzy analysis of remote sensing data for GIS-ready information. *ISPRS J. Photogramm. Remote Sens.* 58, 239–258. doi:10.1016/j.isprsjprs.2003.10.002
- Bertoldi, W., Gurnell, A.M., Drake, N.A., 2011. The topographic signature of vegetation development along a braided river: Results of a combined analysis of airborne lidar, color air photographs, and ground measurements 47, 1–13. doi:10.1029/2010WR010319
- Bertrand, M., Piégay, H., Pont, D., Liébault, F., Sauquet, E., 2013. Sensitivity analysis of environmental changes associated with riverscape evolutions following sediment reintroduction: geomatic approach on the Drôme River network, France. *Int. J. River Basin Manag.* 11, 19–32. doi:10.1080/15715124.2012.754444
- Biron, P.M., Choné, G., Buffin-Bélanger, T., Demers, S., Olsen, T., 2013. Improvement of streams hydro-geomorphological assessment using LiDAR DEMs. *Earth Surf. Process. Landforms* n/a–n/a. doi:10.1002/esp.3425
- Bizzi, S., Demarchi, L., Grabowski, R., Weissteiner, C.J., Van de Bund, W., 2015. The use of remote sensing to characterise hydromorphological properties of European rivers. *Special issue Reform, Acquat. Sci.* (Accepted)
- Bollati, I.M., Pellegrini, L., Rinaldi, M., Duci, G., Pelfini, M., 2014. Reach-scale morphological adjustments and stages of channel evolution: The case of the Trebbia River (northern Italy). *Geomorphology* 221, 176–186. doi:10.1016/j.geomorph.2014.06.007
- Carbonneau, P.E., Piégay, H., 2012. *Fluvial Remote Sensing for Science and Management*. Wiley-Blackwell, Chichester.
- EC, 2000. Directive 2000/60/EC of the European Parliament and of the council: establishing a framework for Community action in the field of water policy. *Off. J. Eur. Communities* L327, 1–71.
- Gurnell, a M., Petts, G.E., Hannah, D.M., Smith, B.P.G., Edwards, P.J., Kollmann, J., Ward, J. V, Tockner, K., 2001. Riparian vegetation and island formation along the gravel - bed Fiume Tagliamento, Italy. *Earth Surf. Process. Landforms* 26, 31–62.
- Leviandier, T., Alber, A., Le Ber, F., Piégay, H., 2012. Comparison of statistical algorithms for detecting homogeneous river reaches along a longitudinal continuum.

- Geomorphology 138, 130–144.  
doi:<http://dx.doi.org/10.1016/j.geomorph.2011.08.031>
- Liébault, F., Cassel, M., Talaska, N., 2013. Long profile responses of alpine braided rivers in se France. *River research and applications* 29, 1253–1266. doi:10.1002/rra
- Liébault, F., Piégay, H., 2001. Assessment of channel changes due to long term bedload supply decrease, Roubion River, France. *Geomorphology* 36, 167–186.
- Marcus, W.A., Fonstad, M.A., 2010. Remote sensing of rivers: the emergence of a subdiscipline in the river sciences. *Earth Surf. Process. Landforms* 35, 1867–1872.
- Marcus, W.A., Fonstad, M.A., Legleiter, C.J., 2012. Management Applications of Optical Remote Sensing in the Active River Channel, in: Carbonneau, P., Piégay, H. (Eds.), *Fluvial Remote Sensing for Science and Management*. Chichester, UK, pp. 19–42.
- Osterkamp, W.R., 1998. Processes of fluvial island formation, with examples from Plum Creek, Colorado and Snake River, Idaho. *Wetlands* 18, 530–545. doi:10.1007/BF03161670
- Pellegrini, L., Maraga, F., Turitto, O., Audisio, C., Duci, G., Pavia, U., Ferrata, V., 2008. Evoluzione morfologica di alvei fluviali mobili nel settore occidentale del bacino padano. *Ital. J. Quat. Sci.* 21, 251–266.
- Phillips, J.D., 2010. The job of the river. *Earth Surf. Process. Landforms* 313, 305–313. doi:10.1002/esp.1915
- Platt, R. V, Rapoza, L., 2008. An Evaluation of an Object-Oriented Paradigm for Land Use/Land Cover Classification. *Prof. Geogr.* 60, 87–100. doi:doi:10.1080/00330120701724152
- Rosso, M., Comino, E., Fresia, I., Dutto, F., 2008. Programma generale di gestione dei sedimenti (pgs) per i corsi d'acqua piemontesi. Programma di gestione dei sedimenti per il torrente Orco. Report.
- Roux, C., Alber, A., Bertrand, M., Vaudor, L., Piégay, H., 2014. "FluvialCorridor": A new ArcGIS toolbox package for multiscale riverscape exploration. *Geomorphology*. doi:10.1016/j.geomorph.2014.04.018
- Schmitt, R., Bizzi, S., Castelletti, A., 2014. Characterizing fluvial systems at basin scale by fuzzy signatures of hydromorphological drivers in data scarce environments. *Geomorphology* 214, 69–83. doi:10.1016/j.geomorph.2014.02.024
- Toone, J., Rice, S.P., Piégay, H., 2014. Spatial discontinuity and temporal evolution of channel morphology along a mixed bedrock-alluvial river, upper Drôme River, southeast France: Contingent responses to external and internal controls. *Geomorphology* 205, 5–16. doi:10.1016/j.geomorph.2012.05.033
- Trimble, 2014. eCognition® Developer 9.0, Reference book.
- Turitto, O., Baldo, M., Audisio, C., Lollino, G., 2010. A LiDAR application to assess long-term bed-level changes in a cobble-bed river: the case of the Orco river (North-West of Italy). *Geogr. Fis. e Din. Quat.* 33, 61–76.
- Tzotsos, A., Argialas, D., 2008. Support Vector Machine classification for object-based image analysis, in: Blaschke, T., Lang, S., Hay, G.J. (Eds.), *Object-Based Image Analysis*. Berlin Heidelberg, pp. 663–678. doi:10.1007/978-3-540-77058-9\_36
- Zevenbergen, L.W., Thorne, C.R., 1987. Quantitative Analysis of Land Surface Topography. *Earth Surf. Process. Landforms* 12, 47–56.

### 3. The Hydromorphological Evaluation Tool (HYMET)

Helmut Habersack, Mario Klösch

BOKU, Vienna (Austria)

River engineering structures such as bank protection or bed sills act as constraints on river morphology and limit morphodynamic processes. Accordingly, the deviations of a river's morphology from a natural reference condition were attributed to the degree of artificiality in the observed river section and river restoration works mainly aimed at reducing artificial constraints within the river reach. Less attention was drawn to alterations of the sediment continuum between sediment production in the river's catchment and downstream river reaches. However, especially in gravel bed rivers, the sediment supply from upstream is strongly reflected by morphodynamics such as bar formation or reworking of the river bed. Any alteration of the quantity of sediment supply (i.e. sediment discharge) or sediment quality (e.g. grain size) may affect the morphological appearance of a reach and determine its deviation from an undisturbed condition.

The Hydromorphological Evaluation Tool (HYMET) accounts for sediment supply and sediment transfer as preconditions for sustainable morphodynamics in river reaches. At the reach scale, artificiality and the sediment budget are assessed. In contrast to existing evaluation methods for assessing hydromorphological state, no reference condition is needed for determining hydro-morphological alterations. Here, with re-established sediment supply and reduced artificiality, a river reach is expected to develop the morphodynamics that approaches a morphodynamically sustainable condition.

Application to the Drau River showed that the alteration of sediment supply strongly affects the evaluation result of a restored reach, indicating remaining potential for re-establishment of morphodynamics through catchment-wide restoration plans.

#### 3.1 Introduction

The European Water Framework Directive (European Commission, 2000) prescribes an evaluation of the ecological state along all European rivers, which includes the assessment of the hydro-morphological condition. Within the existing assessment methods two issues are to be discussed:

1. The hydromorphology of the evaluated reach is assessed by comparing it to that of a reference condition. Most often, a historic state found on maps or aerial images is used to define a pristine, undisturbed condition. However, boundary conditions may have changed which cannot be returned to their historic state (e.g. due to climate change, land use). Hence, the defined reference condition may not correspond to an undisturbed state at present boundary conditions, and may therefore be misleading.
2. The state of sediment supply from upstream finds no or little consideration. However, the sediment regime defines the morphology of alluvial rivers as well as the presence and rate of morphodynamics.

Aiming to overcome these limitations we introduce a method, which evaluates the morphodynamics by assessing the sediment regime as their fundamental basis. Instead of following a hydromorphological reference condition, in a river reach – free from artificial channel constraints – a sustainable sediment regime is assumed to produce a corresponding hydromorphological condition, supporting the good ecological status.

### 3.2 Evaluation - theory

The application of the Hydromorphological Evaluation Tool (HYMET) for reach evaluation follows a three-step process (Figure 3.1). First, the connectivity of the reach to sediment production in its catchment is evaluated. In the second step, the sediment transfer through the river network to the downstream reach is analysed. In the last step, the reach itself is investigated for its own sediment budget and for its artificiality. The evaluation procedure is performed from catchment to reach scale in a hierarchical manner: the score assigned to the reach’s catchment with respect to sediment supply defines the maximum score that can be achieved by the river network score concerning sediment transfer. In turn, the river network score is the maximum possible score that can be achieved by the final reach score. In contrast to existing methods for assessing the morphological quality of rivers, by following HYMET the sediment supply is considered as a prerequisite for sustainable functioning of morphodynamics. The hierarchical procedure ensures causal analysis of morphodynamics rather than interpretation of symptoms observed in the investigated reach.

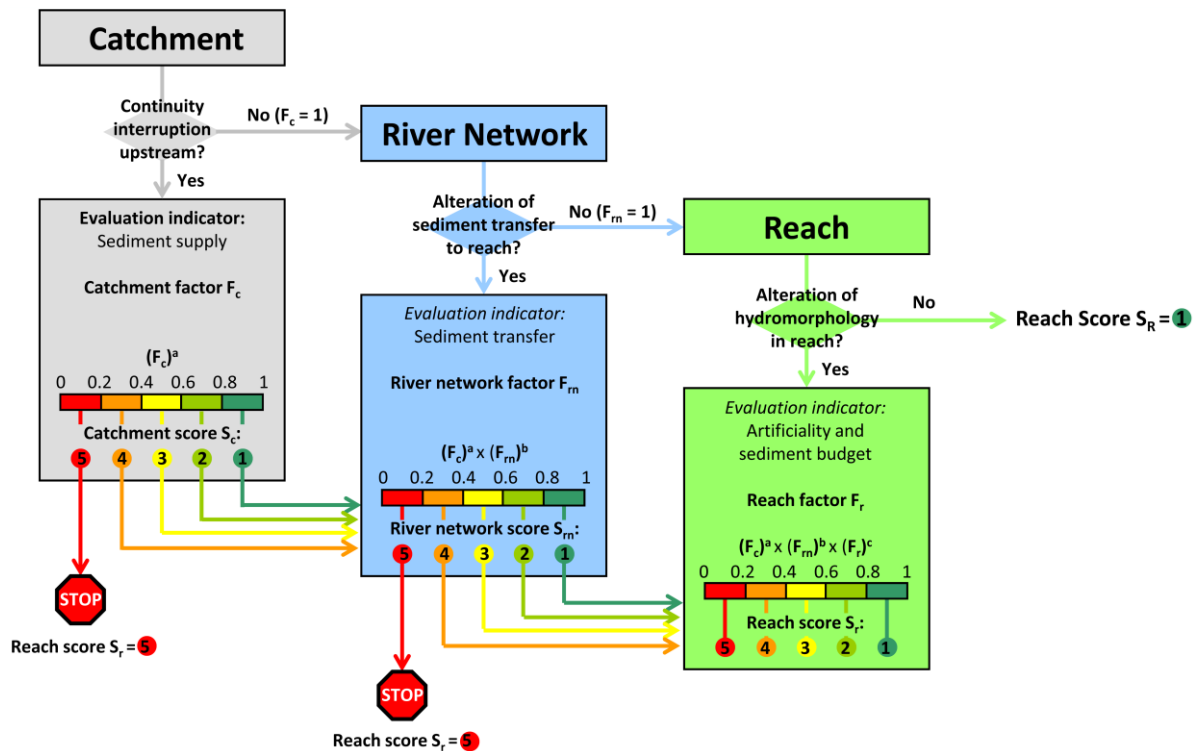

Figure 3.1 Concept of the Hydromorphological Evaluation Tool.

#### 3.2.1. Catchment

The aim of the evaluation at the catchment level is to assess the connectivity of the river network upstream of the evaluated reach to the sediment sources in its catchment, which may be disrupted by artificial sediment barriers (e.g. torrent control structures and weirs from hydropower plants). In HYMET, the connectivity is expressed as the ratio

between sediment supplied to the river network to the totally produced sediment, which would be provided to the river network in the absence of artificial sediment barriers.

### **Determination of sediment production**

Geographic information of the catchment such as hill slope, land cover or geology helps in estimating the relative contribution of sub-catchments to the sediment which enters the river network of the evaluated reach. Sediment transport monitoring in the river network (e.g. Habersack et al., 2013) and/or surveys of catchment topography by aerial photo interpretation (e.g. for assessment of landslide volumes, Brardinoni et al., 2009) may allow calculation of absolute values for sediment production.

### **Determination of sediment barriers and throughput coefficients**

By assigning throughput coefficients to the sediment barriers the proportion of the produced sediment which has access to the river network of the reach is calculated.

Bed load is usually fully trapped in reservoirs, except behind small structures which allow bedload transport over the structure during high discharges (e.g. older torrent control structures with filled reservoirs), newer dams with bypass channels for bedload or newer torrent control structures with increased sediment permeability. Filled reservoirs allow almost 100 % throughput as soon as the longitudinal profile upstream of the structure adjusted to the elevation of the structure (equilibrium profile). However, in the usually short time period since construction of dams or torrent control structures (usually less than 100 years), this state may only be reached at very small structures. Surveys of the reservoir volume and sediment transport measurements upstream or downstream, or bedload transport measurements upstream and downstream would allow a determination of the throughput coefficients. Given the often large number of crossing structures in a catchment compared to few monitoring efforts, the evaluator will probably need to estimate the throughput coefficients based on expert knowledge and/or investigate scenarios of trap efficiency (e.g. the worst case scenario where all reservoirs trap all of the incoming sediment).

For suspended sediment load, Brune (1953) found that the relation between reservoir storage capacity and annual inflow well explains the efficiency of reservoirs in trapping sediment. Kondolf et al. (2014) approximated the relation found by Brune (1953) with the following formula, which may also be used for estimating barrier throughput coefficients in applying HYMET:

$$TE = 1 - 0.05 \cdot \left( \frac{V_r}{V_{wa}} \right)^{-0.5} \quad (1)$$

With TE = trap efficiency,  $V_r$  = total storage volume of the reservoir ( $\text{km}^3$ ), and  $V_{wa}$  mean annual inflow ( $\text{km}^3\text{a}^{-1}$ ).

Artificial compensation of the sediment deficit downstream from weirs may be considered in the evaluation procedure of HYMET. The evaluator may reduce the contribution of artificial sediment supply by means of a sustainability weighting factor, which lets the user define the sustainability of compensation measures.

The catchment factor is calculated as follows:

$$F_c = R_c + R_{ca} w_{sc} \quad (2)$$

with  $R_c$  = ratio of naturally provided sediment,  $R_{ca}$  = ratio of artificially provided sediment for compensation of supply deficits, and  $w_{sc}$  = weighting factor for consideration of artificial sediment supply in evaluation ( $w_{sc} = 0$ : artificial sediment supply is not considered in evaluation;  $w_{sc} = 1$ : artificial sediment supply is considered as equally important as natural sediment supply from catchment).

$R_c$  is calculated via:

$$R_c = \frac{Q_{sc} + Q_{sbt}}{Q_{scp}} \tag{3}$$

With  $Q_{sc}$  = produced sediment in catchment with free access to reach (no continuity interruption between location of sediment production and reach),  $Q_{sbt}$  = sediment discharge through barriers (e.g. average sediment discharge through temporarily opened weirs),  $Q_{scp}$  = sediment discharge produced in entire hydrological catchment of reach.

$Q_{sbt}$  of one chain of sediment barriers is calculated based on the throughput coefficients  $t$  assigned to every sediment barrier, the sediment produced in the catchments between each barrier and the next barrier upstream, and the sequence of sediment barriers (see also Figure 3.2):

$$Q_{sbt} = \sum_{i=1}^n t_{1i} Q_{scp1i} + t_{1i} \sum_{j=1}^n t_{2ij} Q_{scp2ij} + t_{1i} t_{2ij} \sum_{k=1}^n t_{3ijk} Q_{scp3ijk} \dots \tag{4}$$

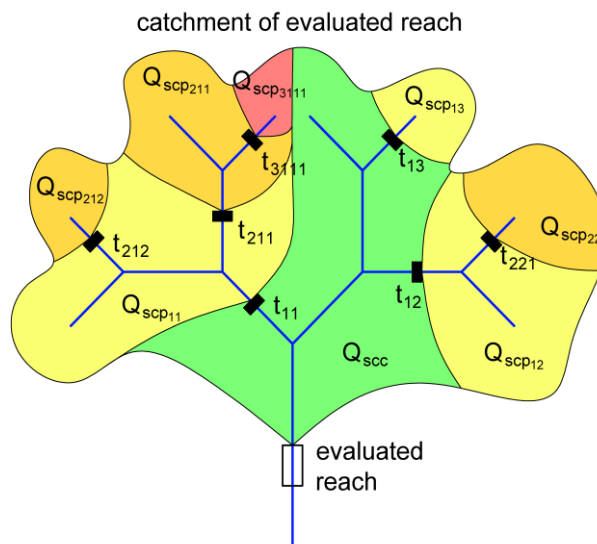

**Figure 3.2 Definition of variables and indexing in Eq. 4 along chains of hydropower plants.**

In a similar manner the ratio of artificial compensation of sediment retention is calculated:

$$R_{ca} = \frac{Q_{sba}}{Q_{scp}} \tag{5}$$

where  $Q_{sba}$  is the artificially provided sediment downstream of sediment barriers.  $Q_{sba}$  is calculated as follows (see also Figure 3.3):

$$Q_{sba} = \sum_{i=1}^n Q_{sba1i} + t_{1i} \sum_{j=1}^n Q_{sba2ij} + t_{1i} t_{2ij} \sum_{k=1}^n Q_{sba3ijk} \dots \tag{6}$$



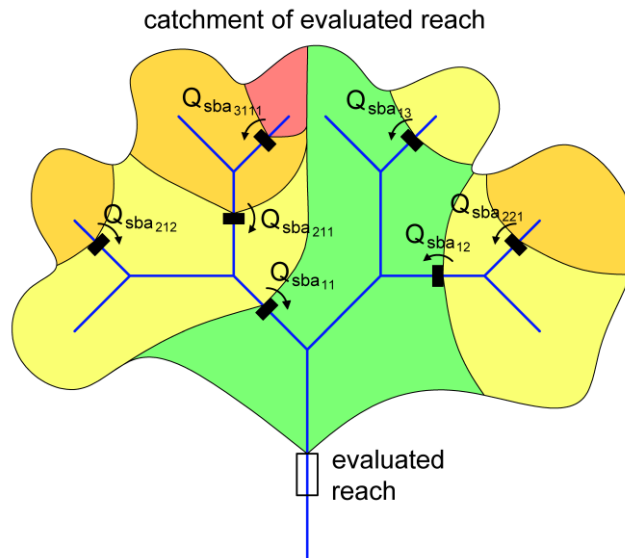

**Figure 3.3 Definition of variables and indexing in Eq. 6 along chains of hydropower plants.**

Once a throughput coefficient of a sediment barrier equals zero (meaning impermeability with respect to sediment transport), it is obsolete to determine upstream values. Hence, to minimize efforts, data should be collected from downstream to upstream.

The reach’s catchment score  $S_c$  is derived by calculation of  $(F_c)^a$ , with the exponent  $a$  for adjusting thresholds between marks based on five intervals (Table 3.1).

**Table 3.1 Marking at the catchment level based on the catchment factor  $F_c$ .**

$(F_c)^a$	Score at catchment level	Connectivity of reach to sediment production in its catchment
0.0 - 0.2	5	very bad
0.2 - 0.4	4	bad
0.4 - 0.6	3	acceptable
0.6 - 0.8	2	good
0.8 - 1.0	1	very good

### 3.2.2. River Network

The river network is investigated for alterations of the transfer of sediment from the catchment to the downstream, investigated reach. River engineering works in the upstream river network may alter the sediment budget by changing the sediment transport capacity. Training works such as channel narrowing may increase bed shear stress and hence sediment transport. Moreover, gravel mining or artificial sediment supply affects the sediment budget of the river network. Degradation (bed level lowering and/or channel widening) in upstream reaches would increase, and aggradation (bed level increase as well as channel narrowing) would decrease the amount of sediment which is transferred downstream. Mostly, aggradation, degradation and especially dredging activities and artificial sediment supply occur over a limited time. A reduction or increase of sediment supply to the investigated reach would therefore imply that the actual morphological condition of the reach, whether it resembles a natural or an altered

condition, is temporary. By evaluating the sediment transfer within the river network, the sustainability of the morphological condition is considered in the evaluation.

Depending on data availability, the sediment transfer through the river network may be calculated based on monitoring data or estimated via expert knowledge. Frings et al. (2014) established a sediment budget for the regulated Rhine River for a 21-year period (1985-2006). Based on the budget components used in Frings et al. (2014), the following budget can be established for rivers, where bank erosion may occur (Figure 3.4):

$$(I_u + I_t + I_a + I_b) - (O_d + O_e + O_f + O_a) = \Delta S \tag{7}$$

with  $I_u$  sediment input from upstream,  $I_t$  sediment input from tributaries,  $I_a$  artificial sediment supply,  $I_b$  sediment supply from bank erosion,  $O_d$  sediment transport out of the river section at the downstream end,  $O_e$  sediment extraction,  $O_f$  floodplain sedimentation,  $O_a$  abrasion, and  $\Delta S$  change of stored sediment due to bed level changes. Units are uniformly in  $m^3/a$ .

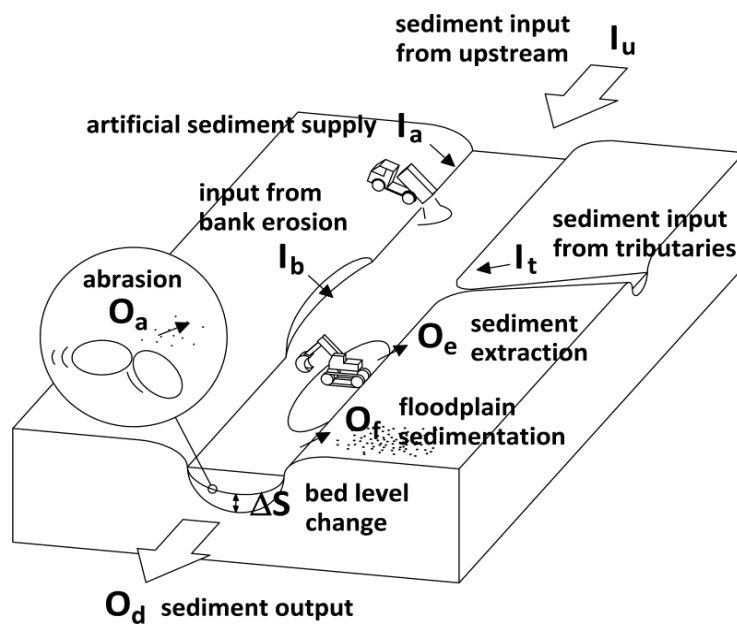

**Figure 3.4 Components of sediment transfer determining the sediment supply to a downstream river reach.**

In case the cross section surveys also cover the riverbanks and the floodplain, supply from bank erosion ( $I_b$ ) and sediment output through floodplain sedimentation ( $O_f$ ) may be subsumed together with bed level changes in  $\Delta S$ . In a cross section downstream of a cross section with known sediment transport, the sediment transport can then be calculated via:

$$O_d = (I_u + I_a + I_t) - (\Delta S + O_e + O_a) \tag{8}$$

The reach network factor  $Fr_n$  is defined as follows:

$$F_{rn} = 1 - \left| 1 - \frac{Q_{sr} - (1 - w_{srn})Q_{rna}}{Q_{scc} + Q_{sbt} + Q_{sba}} \right| \quad (9)$$

with  $Q_{sr}$  = sediment discharge entering the evaluated reach,  $w_{srn}$  = weighting factor for considering sustainability of sediment supply to the reach in evaluation ( $w_{srn} = 0$ : artificial sediment supply/extraction is not considered in evaluation;  $w_{srn} = 1$ : artificial sediment supply/extraction is considered equal to natural sediment transfer) and  $Q_{rna}$  = artificially supplied and/or extracted sediment in river network.

$Q_{rna}$  includes artificial sediment extractions and supplies also in river sections upstream of sediment barriers:

$$Q_{rna} = (Q_{sup} - Q_{extr}) + t_{1j}(Q_{sup1j} - Q_{extr1j}) + t_{1j}t_{2ij}(Q_{sup2ij} - Q_{extr2ij}).. \quad (10)$$

with  $Q_{sup}$  = artificially supplied sediment in river network and  $Q_{extr}$  = extracted sediment in river network (e.g. gravel mining).

The reach's score at the river network level  $S_{rn}$  characterises the condition of sediment supply to the reach and is derived by classification of the product  $(F_c)^a \times (F_{rn})^b$  into five intervals (Table 3.2), with the exponent  $b$  adjusting thresholds between classes used for marking.

**Table 3.2 Marking of sediment supply to the reach, performed at the river network level based on the product of  $(F_c)^a$  and  $(F_{rn})^b$ .**

$(F_c)^a \times (F_{rn})^b$	Score at river network level	Sediment supply to reach
0.0 - 0.2	5	very bad
0.2 - 0.4	4	bad
0.4 - 0.6	3	acceptable
0.6 - 0.8	2	good
0.8 - 1.0	1	very good

The obtained values for sediment transfer have to be evaluated with consideration of the flow events in the investigated time period. The results of sediment budget analyses tend to include significant temporal and spatial clumping (Walling, 1983), especially when obtained from short timeframes.

Figure 3.5 displays the application of HYMET down to the level of the river network for a schematic representation of a reach's catchment. In Figure 3.5a a schematic catchment and network of an evaluated reach is influenced by two sediment barriers (with throughput coefficients of 0 and 0.5) and river sections with sediment transport in non-equilibrium (degrading and aggrading reaches). For better traceability of the evaluation procedure and the effects of sediment barriers and non-equilibrium river sections, the sediment production and its entrance into the river network is evenly distributed over the entire catchment. Figure 3.5b displays the derived sediment discharge along the river for three conditions of sediment transfer, which are subsequently used for the evaluation of the catchment and river network:

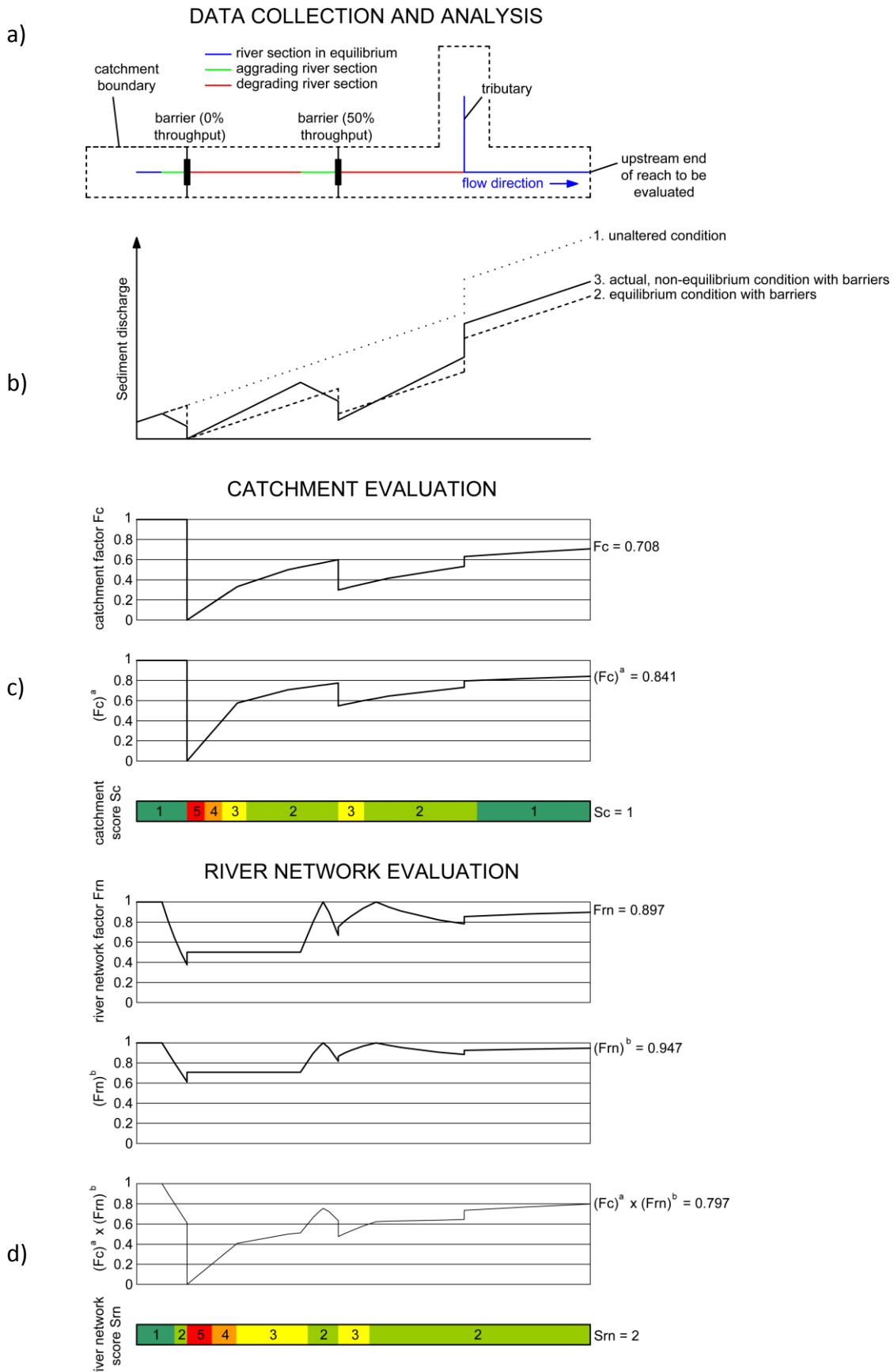

**Figure 3.5 Application of HYMET to a schematic river catchment and network of an evaluated reach.**

### *Condition 1: Unaltered condition of sediment discharge*

At unaltered conditions all the sediment produced in the catchment (all but the sediment trapped for long-term in natural barriers such as lakes) is steadily transported downstream. Given the absence of e.g. river regulation, the conveyance of the river morphologies is assumed to be fully adjusted to the sediment supply at unaltered conditions.

### *Condition 2: Equilibrium condition of sediment discharge in the presence of sediment barriers*

This scenario reflects steady transport of sediment which is not trapped and removed behind sediment barriers.

### *Condition 3: Actual, eventual non-equilibrium condition of sediment discharge in the presence of sediment barriers*

This state is derived from the actually observed or measured sediment discharge.

The catchment evaluation is performed by relating the sediment discharge of condition 2 to condition 1 (using the formulas of the chapters above). The exponent  $a$  is applied to the factor  $F_c$  for adjusting marking thresholds (In Figure 3.5c the exponent  $a$  was set 0.5). In case the catchment evaluation shows the desired condition (acceptable or better), the sediment discharge of condition 2 is the desired condition of sediment transfer in the river network. For the schematic river catchment in Figure 3.5, the catchment score at the upstream end of the evaluated reach is 1 ('very good' condition).

The reach's river network evaluation (subsuming the conditions of catchment and river network in Figure 3.5d) may reach the same score as the reach's catchment if condition 3 of sediment transfer approaches condition 2. Again an exponent (exponent  $b$ ) is used to adjust the marking thresholds (In Figure 3.5c  $b$  was set 0.5). The sediment discharge of condition 3 is slightly above the sediment discharge of condition 2; this difference results in a river network factor  $F_m$  which is slightly below 1 (0.897) and the product  $(F_c)^a \times (F_m)^b$  gives 0.797 and hence a final river network score 2 for the evaluated reach.

### **3.2.3. River reach**

While morphodynamics evolve with local bed aggradation or degradation, within the length of the river reach the sediment budget has to be balanced in a dynamic equilibrium to maintain the morphological condition. This may be investigated based on repeated surveys of the channel geometry (cross section surveys or surveys including the entire channel). Second, the degree of artificiality is evaluated at the reach scale, since the sediment budget in a reach may be balanced just because of artificial interference in the channel processes. Non-erodible crossing structures or artificial sediment supply may prevent bed degradation, and a narrowed channel due to groynes or repeated dredging may prevent aggradation.

The reach factor  $F_r$  is calculated as the product of four partial factors:

$$F_r = f_{rb} f_{rl} f_{rv} f_{rse} \quad (11)$$

with  $f_{rb}$  = sediment budget factor of the reach,  $f_{rl}$  = factor expressing artificial lateral constraints to channel morphology,  $f_{rv}$  = factor expressing artificial vertical constraints to channel morphology,  $f_{rse}$  = factor expressing artificial sediment supply or extraction.

#### **Reach sediment budget**

The mean bed level change is taken as an indicator for the state of the sediment budget in the reach:

$$\Delta H_a = \frac{(Q_{sra} - Q_{era})}{LB} \quad (12)$$

Where  $\Delta H_a$  = average annual bed level change,  $Q_{sra}$  = annual sediment supply to reach,  $Q_{era}$  = annual sediment yield exiting the reach,  $L$  = reach length,  $B$  = average channel width in reach. As the entire channel geometries are compared,  $\Delta H_a$  also comprises lateral changes (bank erosion and accretion). A yearly bed level change of more than 0.04 m is defined as a sediment budget in a very bad condition. Accordingly, the budget factor of the reach  $f_{rb}$  is calculated as follows:

$$f_{rb} = 1 - \left| \frac{\Delta H}{0.05} \right| \quad (13)$$

$f_{rb}$  is set to 0 if the absolute value of  $\Delta H_a$  is greater than 0.05 m.

### **Reach artificiality**

The evaluation of artificiality comprises lateral and vertical constraints, as well as artificial sediment supplies or extraction.

#### Lateral constraints to morphology

The lateral constraints are assessed along the water edge at approximately mean discharge. There, the proportion of protected banks is calculated. If a bank is protected but not reached by the water edge (e.g. due to the presence of an alternate bar), this is not counted as a channel constraint. In contrast, submerged structures need to be fully accounted for. Groynes constrain the channel over a larger length than the extent of the structure itself along the channel. To account for that, the length of the pool at the groyne head is used as a replacement length. The water edges along mid-channel bars are equally considered. Natural constraints (e.g., bedrock) are not considered as protected banks. The ratio between the length of water edges along structures and the overall length of the water edge describes the artificiality with respect to lateral channel boundaries. This ratio is expressed by the factor  $f_{rl}$ , which is calculated as follows:

$$f_{rl} = 1 - \frac{L_{ba}}{L_b} \quad (14)$$

where  $L_{bp}$  = length of protected banks,  $L_{bpa}$  = length of protected banks showing accretion,  $L_b$  = overall bank length.

#### Vertical constraints

River morphology reacts very sensitive to vertical constraints, so that if a structure crosses the reach or if the bed is paved the factor  $f_{rv}$  (factor expressing artificial vertical constraints within the reach) is set 0, otherwise  $f_{rv} = 1$ .

#### Artificial sediment supply/extraction

Similarly to vertical constraints, repeated artificial sediment supply or extraction in the reach is considered as a knock-out criterion for the evaluation of the reach. Accordingly,  $f_{rse}$  (factor expressing artificial sediment supply or extraction) can take the value 1 or 0.

The final reach score  $S_r$  characterises the overall preconditions for sustainable morphodynamics in the reach and is derived by classification of the product  $(F_c)^a \times (F_m)^b \times (F_r)^c$  into five intervals (Table 3.3), with the exponent  $c$  adjusting thresholds between the classes used for marking.

**Table 3.3 Marking of the preconditions for sustainable morphodynamics in the reach, performed at the reach level based on the product of the catchment factor  $F_c$ , river network factor  $F_{rn}$  and reach factor  $F_r$ .**

$(F_c)^a \times (F_{rn})^b \times (F_r)^c$	Score at reach level	Preconditions for sustainable morphodynamics in reach
0.0 - 0.2	5	very bad
0.2 - 0.4	4	bad
0.4 - 0.6	3	acceptable
0.6 - 0.8	2	good
0.8 - 1.0	1	very good

### **3.3 Application**

The application of HYMET is exemplified here on a restored reach of the Drau River for the time period between 2008 and 2013. First, data has to be collected at the catchment level, which comprises data concerning sediment production and sediment barriers in the catchment upstream from the investigated reach. In case of a catchment score of 4 (bad) or better, the data collection continues with the river network, where data concerning the sediment budget is relevant. Finally, if a river network score of 4 (bad) or better is obtained, data expressing the artificiality and the sediment budget of the investigated reach itself have to be investigated. In case of reduced data availability, parameters which are necessary for the application of HYMET have to be estimated.

#### **3.3.1. Data collection**

Two kinds of data may be used for the application of HYMET. Data may be derived from measurements (e.g. surveys, sediment transport measurements) or may be based on experts' estimates.

##### **Catchment data**

###### Data concerning sediment production

For estimation of the sediment production in the catchment upstream from the investigated reach of the Drau River, the sediment production in a subcatchment was assumed to correspond to the proportion of the subcatchment's area on the entire catchment's area.

###### Data concerning sediment barriers

A map containing the locations of every barrier disabling fish passage and corresponding meta data was used for identification of sediment barriers in the catchment (Figure 3.6). Based on their design, the sediment barriers were classified into non-permeable and semipermeable barriers, with estimated throughput coefficients of 0 and 0.5 correspondingly. Together with the calculated sediment production in sub-catchments, the reducing effect of sediment barriers on sediment supply to the river network could be estimated. Sediment retention upstream from weirs is only compensated by reservoir flushing during floods, which is already considered by the throughput coefficient. In Austria, generally, dredged sediments from the reservoirs are not reintroduced into the downstream channel. According to Austrian law, once the retained sediment is taken out of the reservoir, it is classified as waste material which requires appropriate disposal.



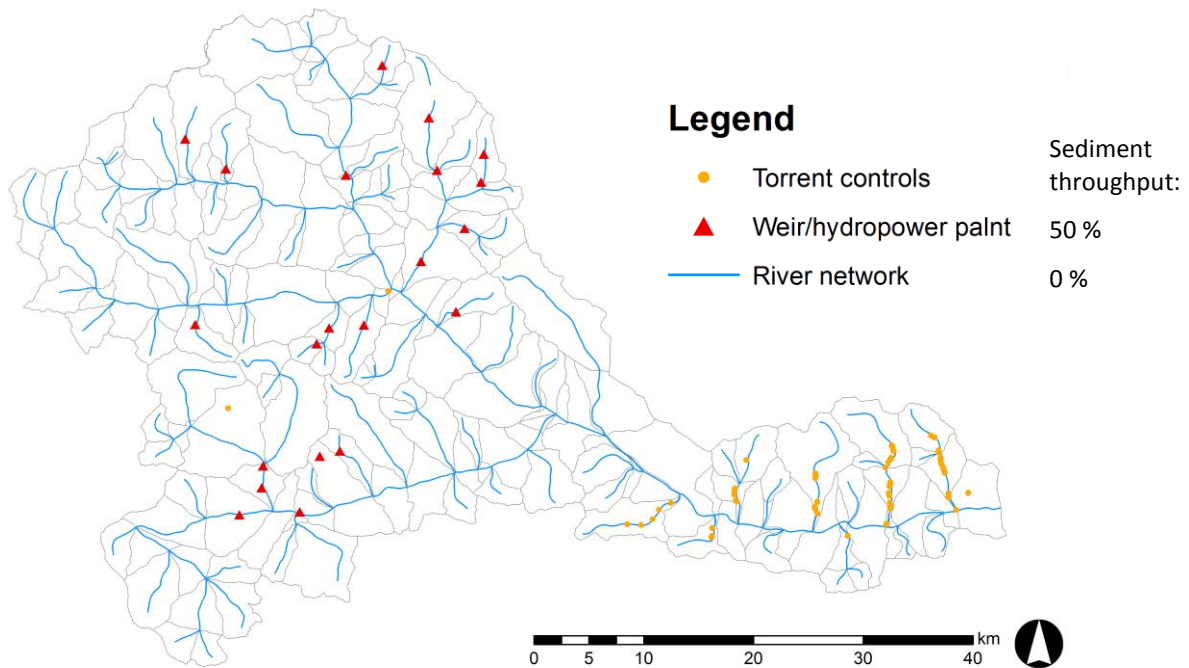
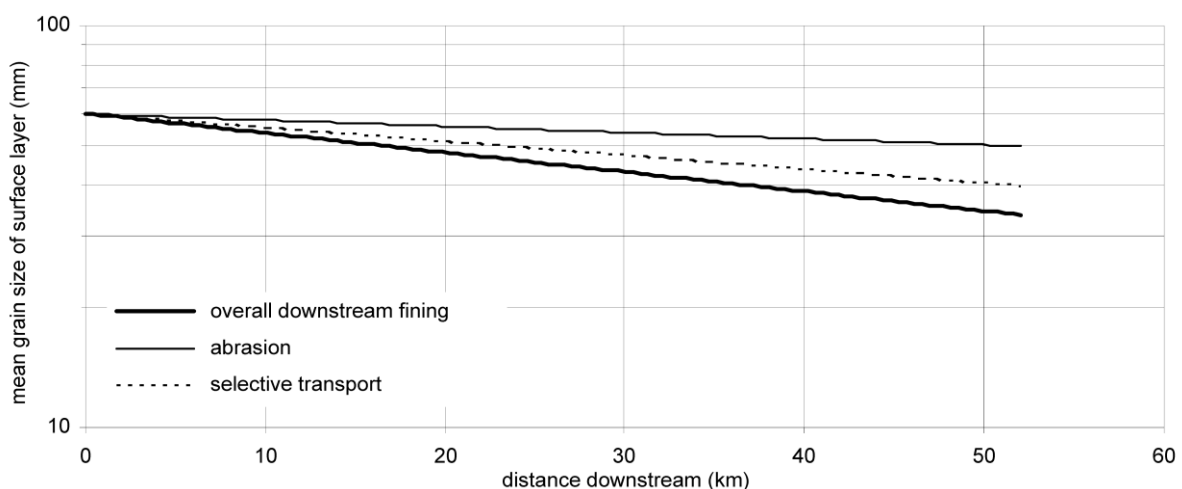

**Figure 3.6 Sediment barriers and assigned sediment throughput coefficients in the catchment of the investigated reach.**

**River network data**

Data concerning sediment budget

The Carinthian government performed water level measurements during low flow in winter, in mostly yearly intervals since 1886. Additionally, since 1991, 4 data sets from repeated cross section surveys are available. Both data sets allow investigating the bed level changes and corresponding sediment budgets. Large substrate samples along the entire Upper Drau River gave insight into downstream fining due to selective transport and abrasion (Figure 3.7; Habersack, 1997). Moreover, high efforts were made in measuring sediment transport, using basket samplers and bedload traps since the 1990s and continuous measurement with geophones since 2006.



**Figure 3.7 Effects of abrasion on grain size in the Upper Drau River (Habersack, 1997)**

Data concerning artificial sediment supply/sediment extraction

Intensive gravel mining up to the 1990s and sediment excavation during excavation works significantly affected the sediment budget of the Upper Drau River (Figure 3.8). Habersack (1997) attested gravel mining to have caused 69% of the observed channel incision in the time period between 1931 and 1991. Hence, data was collected concerning dredging activities in the course of restoration works as well as data concerning the amounts of reintroduced sediment within the investigated period between 2008 and 2013.

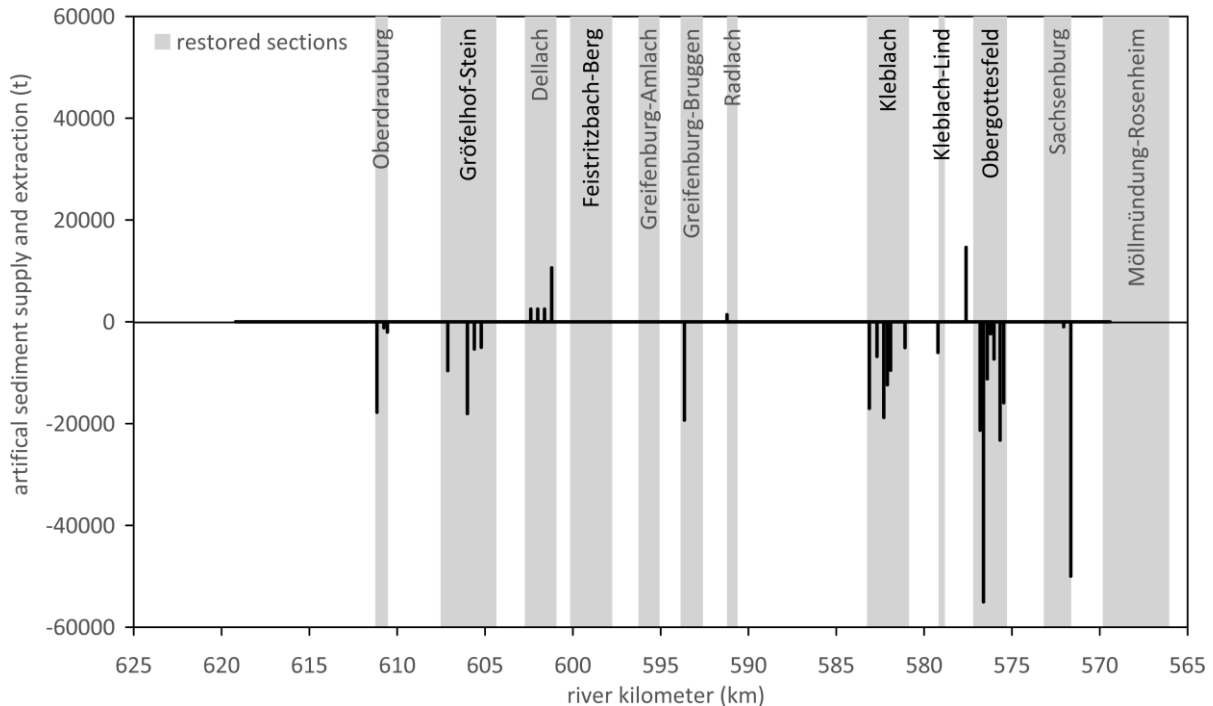

**Figure 3.8 Gravel mining and supply along the Drau River Valley in the time period 1991-2013.**

### **Reach data**

For evaluation of the investigated reach at the reach level, cross section surveys were available for investigation of the sediment budget. The results of a 2D-hydrodynamic-numerical model and field visits were used to assess the influence of channel constraints (bank protection, groynes, etc.) on the reach morphology and hence the artificiality of the reach.

### **3.3.2. Application - Sediment connectivity assessment**

#### **Catchment Evaluation**

Figure 3.9 displays the connectivity of the reach to the upstream sub-catchments. Based on this connectivity of the sediment production to the river network ( $F_c = 0.52$ ) and a value of 0.4 for exponent  $a$ , a catchment score of 2 (good) was obtained.

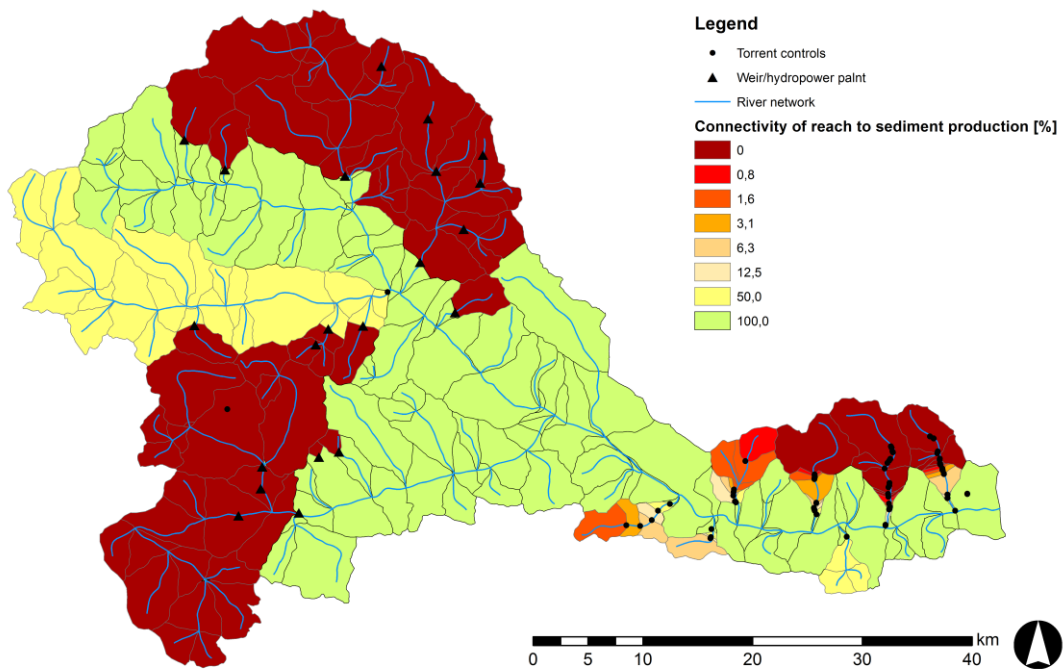
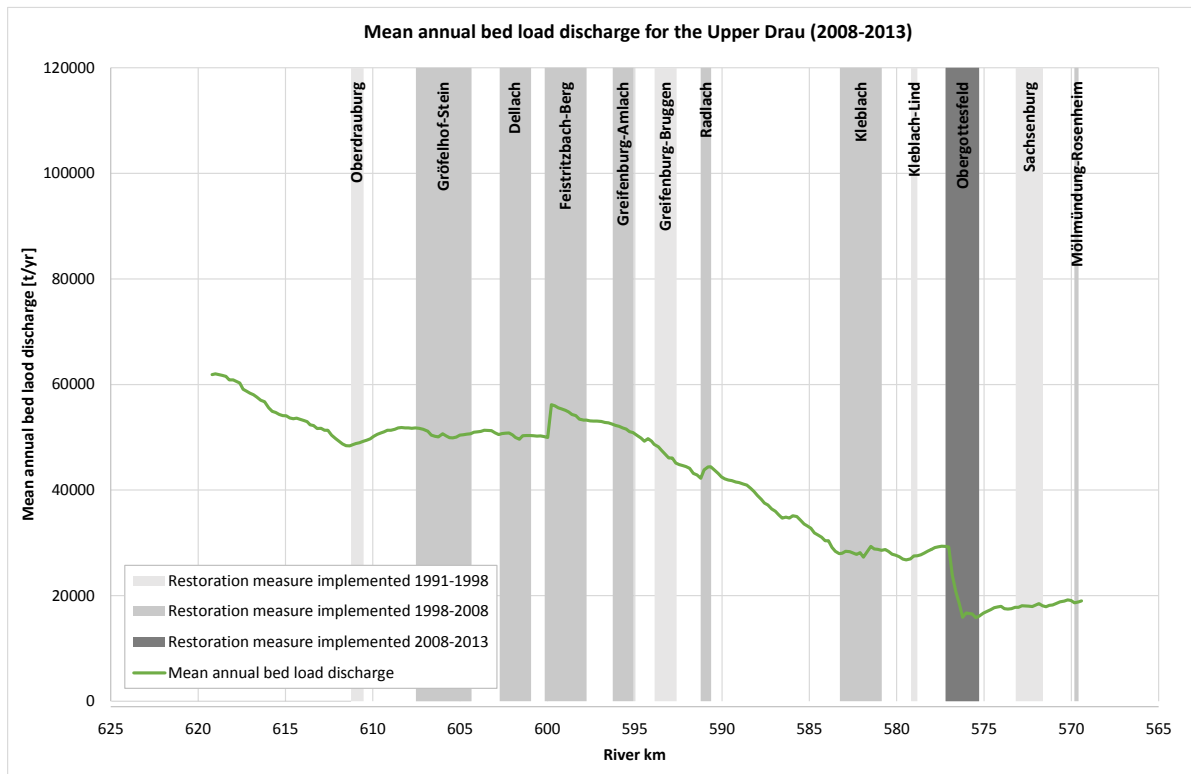

**Figure 3.9. Connectivity of the produced sediment in sub-catchments to the investigated reach based on throughput coefficients of sediment barriers.**

### **River network evaluation**

Based on the bedload rating curve obtained at the monitoring site in Dellach and the repeated cross section surveys along the entire Upper Drau, the longitudinal variation of bedload transport was calculated (Figure 3.10). Assuming that no significant changes occurred upstream from that section, the bedload discharge calculated at the upstream end could be compared to the bedload discharge that was supplied to the reach (restored reach 'Kleblach') to evaluate the sediment transfer. The supplied bedload is about half the amount that entered the river network ( $F_m = 0.45$ ). As only bedload was analysed, the bedload reducing effect of abrasion had to be considered.

The river network score is a combination of the catchment factor and the river network factor. Accordingly, the overall state of sediment supply is in an acceptable condition:  $(F_c)^a \times (F_m)^b = 0.56$  with  $b = 0.4$  gives a river network score of 3. After a torrent control (Feistritzbach) was replaced by a more permeable structure in the year 2009, the sediment that was mobilised after reconstruction significantly increased the bedload transport at river-km 600. More similar measures in tributaries would improve the river network score.

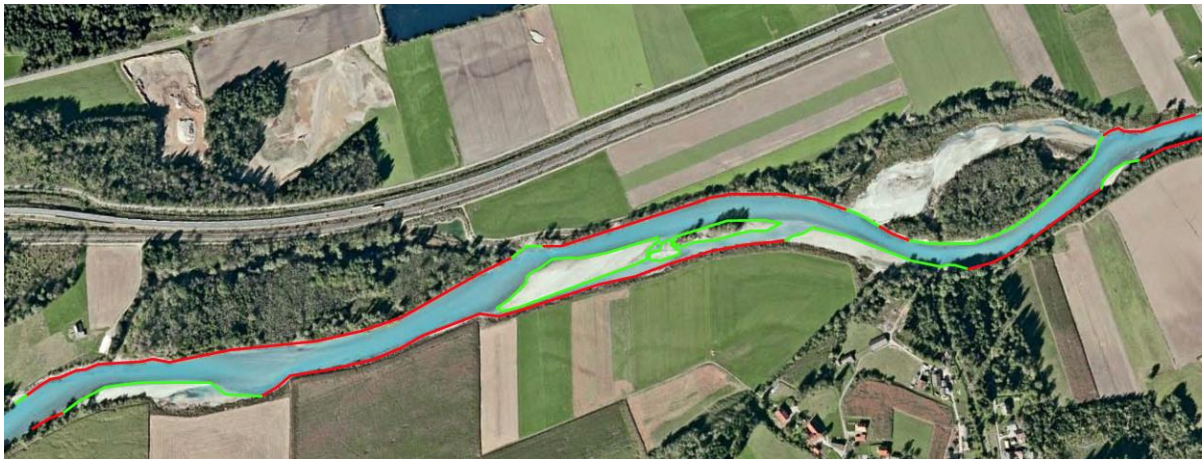

**Figure 3.10 Mean annual bed load yield along the Upper Drau between 2008 and 2013.**

**Reach evaluation**

Finally, the reach is investigated for its artificiality and its sediment budget. Both determine the reach factor, which in combination with the catchment and the river network factor determines the final reach score.

As can be noted, in the time period between 2008 and 2013 the restored reach at Kleblach already reached a balanced sediment budget after its implementation in 2002/2003 ( $f_{rb} = 1$ ). The artificiality was already strongly reduced by the restoration measures. Figure 3.11 shows the constraints along the water edges at approximately mean discharge, which represent the artificiality of the reach ( $f_{rl} = 0.43$ ). In case of very good conditions of sediment supply (River network Score  $S_c = 1$ ), the evaluated reach would obtain a reach score of 2 (good) or a stable 3 (acceptable) condition. However, given the preconditions of sediment supply defined by alterations in the catchment and in the river network, the overall conditions in the reach for sustainable morphodynamics are barely rated as acceptable (3), on the edge to a bad (4) condition (based on  $(F_c)^a \times (F_{rn})^b \times (F_r)^c = 0.40$ ).



**Figure 3.11 Bank protection constraining the flow at mean discharge in the evaluated reach (restored state in 2008).**

### 3.4 Summary

The Hydromorphological Evaluation Tool is essential for evaluating regulated or restored river reaches as a precondition for an integrated morphological quality assessment and to find measures at the appropriate scale. It is clear that in a hierarchical scaling dependency of the smaller scales from the larger ones the integration of catchment, landscape unit and segment scale processes is crucial for planning and implementation of sustainable river engineering measures, hydropower development, river restorations and flood risk management at the reach scale.

### 3.5 References

- Brardinoni F., Hassan M.A., Rollerson T., Maynard D., 2009. Colluvial sediment dynamics in mountain drainage basins. *Earth and Planetary Science Letters* 284 (3), 310-319.
- Brune, Gunnar M., 1953. Trap Efficiency of Reservoirs. *Transactions of American Geophysical Union*, vol . 34, No. 3, June 1953.
- European Commission, 2000. Directive 2000/60/EC of the European Parliament and of the Council of 23 October 2000 Establishing a Framework for Community Action in the Field of Water Policy. *Official Journal L 327*, 22/12/2000, Brussels, Belgium. 73 pp.
- Frings R.M., Gehres N., Promny M., Middelkoop H., Schüttrumpf H., Vollmer S., 2014. Today's sediment budget of the Rhine River channel, focusing on the Upper Rhine Graben and Rhenish Massif, *Geomorphology*, Volume 204, 573-587.
- Habersack H., 1997. Raum-zeitliche Variabilitäten im Geschiebehaushalt und dessen Beeinflussung am Beispiel der Drau. *Wiener Mitteilungen*, 144.
- Habersack, H., Aigner J., Kreisler, A., Seitz H., 2013. Geschiebemessungen an Drau und Isel 2007-2012, Endbericht. Studie im Auftrag des Bundesministeriums für Land- und Forstwirtschaft, Umwelt und Wasserwirtschaft; Amt der Tiroler und Kärntner Landesregierung. Wien.
- Kondolf G.M., Rubin Z.K., Minear J.T., 2014. Dams on the Mekong: Cumulative sediment starvation, *Water Resour. Res.*, 50, 5158–5169, doi:10.1002/2013WR014651.
- Walling D.E., 1983. The sediment delivery problem. *Journal of Hydrology* 65: 209–237.